



Diagnostics



Buck
BI-1-101-18
Percussion Hammer
18.5cm,



Buck
BI-1-102-18
Percussion Hammer
20cm,

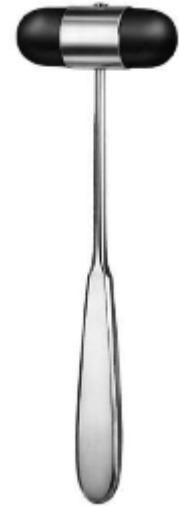

Dejerine
BI-1-103-20
Percussion Hammer
20cm,



Dejerine
BI-1-104-21
Percussion Hammer
21cm,



TaylorMod.USA
BI-1-105-20
Percussion Hammer
20cm,



Wartenberg
BI-1-106-19
Pinwheel
18cm,

Diagnostics



Pinard
BI-1-107-18
Stethoscope
18cm,



Pinard
BI-1-108-15
Stethoscope
15cm,

Anesthesia



Magill
BI-2-101-15
Catheter Introducing Forceps
14.5cm, 20cm, 25cm,



Miller
BI-2-102-00
Laryngoscope Sets



Miller-Baby
BI-2-103-00
Laryngoscope Sets



Miller
BI-2-104-00
Laryngoscope Blade
Fig.0, Fig.1, Fig.2, Fig.3, Fig.4,



Guedel-Negus
BI-2-105-00
Laryngoscope Sets
Fig.2, Fig.3, Fig.4,



Guedel-Negus
BI-2-106-00
Laryngoscope Sets
Fig.1, Fig.2, Fig.3, Fig.4,

Anesthesia



**Guedel-Negus
BI-2-107-01**

LaryngoscopeBlades
Fig.1, Fig.2, Fig.3, Fig.4,



**McIntosh
BI-2-108-00**



**McIntosh
BI-2-109-00**

LaryngoscopeBlades
Fig.0, Fig.1, Fig.2, Fig.3, Fig.4,



**McIntosh
BI-2-110-00**

LaryngoscopeSets
Fig.1, Fig.2, Fig.3, Fig.4,



**Foregger
BI-2-111-01**

LaryngoscopeBlades
Fig.1, Fig.2, Fig.3, Fig.4,



**BatteryHandle
BI-2-112-00**
BatteryHandle

Anesthesia



McIntosh
BI-2-114-00
LaryngoscopeSetsfiberoptic
Fig.1, Fig.2, Fig.3,



McIntosh
BI-2-115-00
LaryngoscopeSetsfiberoptic
Fig.1, Fig.2, Fig.3,



McIntosh
BI-2-116-00
LaryngoscopeSetsfiberoptic
Fig.1, Fig.2, Fig.3,



McIntosh
BI-2-113-00
LaryngoscopeSets
Fig.1, Fig.2, Fig.3, Fig.4,

Trocars



Universal
BI-3-101-04
Trocar
14cm,



Nelson
BI-3-102-07
Trocar
20cm,



Lichtwitz
BI-3-103-19
Antrum Trocar
18.5cm,



Adson
BI-3-104-21
Suction Cannula
20cm,



Frazier
BI-3-105-10
Suction Cannula
24cm,



Frazier
BI-3-106-06
Suction Cannula
19.5cm,

Trocars



Poppen
BI-3-107-06
 Suction Cannula
 18cm,



Luer
BI-3-108-30
 Suction Tube working length 110mm



Yasargil
BI-3-109-15
 Suction Tube working length 150mm with
 Luerhub
 21.5cm,



Yankauer
BI-3-110-27
 Suction Tube complete with suction tip and
 connector
 31cm,



Yankauer
BI-3-111-00
 Suction Tube
 31cm, 15cm, 2.5cm, 10cm,



Poole
BI-3-112-22
 Suction Tube
 22cm,

Trocars



Poole
BI-3-113-22
Suction Tube
22.5cm,



Nuboer
BI-3-114-21
Suction Tube
21cm,



Nuboer
BI-3-115-21
Suction Tube
21cm,



Quinke
BI-3-116-10
Lumbar Puncture Needle



Tuohy
BI-3-117-12
Lumbar Puncture Needle Luer Lock
connection with special tip



Verres
BI-3-118-20
Insufflation Cannula Luer Lock connection
15cm,

Trocars

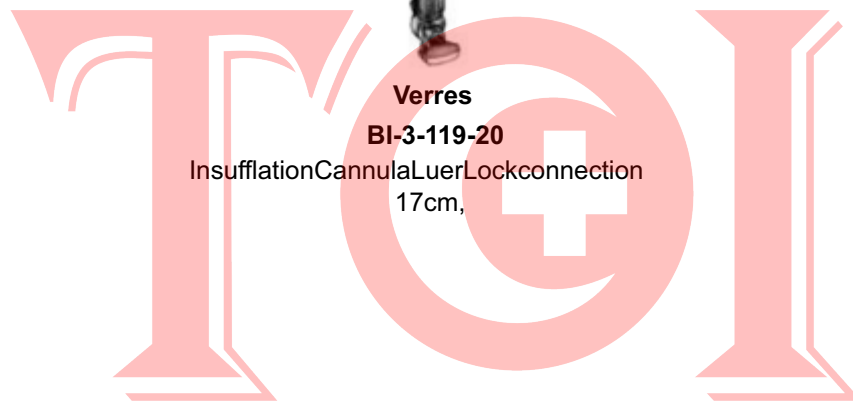

Verres
BI-3-119-20
Insufflation Cannula Luer Lock connection
17cm,

Suture



Kalt
BI-4-105-14
 NeedleHolder
 13.5cm,



Barraquer-Troutman
BI-4-106-10
 MicroNeedleHolder
 10cm, 10.5cm,



Arruga
BI-4-107-14
 MicroNeedleHolder
 13.5cm,



Barraquer-Troutman
BI-4-108-10
 MicroNeedleHolder
 10.5cm, 11.5cm,



Barraquer
BI-4-109-11
 MicroNeedleHolder
 11.5cm, 13.5cm, 14cm,



Barraquer
BI-4-110-13
 MicroNeedleHolder
 13.5cm,

Suture



Castroviejo-Fino
BI-4-111-01
 MicroNeedleHolder
 13cm,



Castroviejo-Fino
BI-4-112-01
 MicroNeedleHolder
 13cm,



Castroviejo-Fino
BI-4-113-01
 very delicate jaw with lock
 13cm,



Castroviejo
BI-4-114-14
 MicroNeedleHolder with lock
 14cm,



Castroviejo
BI-4-115-14
 MicroNeedleHolder
 14cm,



Castroviejo
BI-4-121-14
 MicroNeedleHolder with lock
 14cm,

Suture



Castroviejo
BI-4-122-14
 MicroNeedleHolder
 14cm,



Castroviejo
BI-4-124-13
 MicroNeedleHolderwithlock
 12cm,



Arruga
BI-4-123-16
 NeedleHolderdelicate
 16cm,



Castroviejo
BI-4-125-12
 MicroNeedleHolderwithlock
 12cm,



Derf
BI-4-126-12
 NeedleHolder
 12cm, 13cm,



Collier
BI-4-127-12
 NeedleHolder
 12.5cm,

Suture



Webster
BI-4-128-13
 NeedleHolder
 13cm,



Halsey
BI-4-129-13
 NeedleHolder
 13.5cm,



Neivert
BI-4-130-13
 NeedleHolder
 12.5cm,



Hegar-Baumgartner
BI-4-131-14
 NeedleHolder
 14.5cm,



Crile-Murray
BI-4-133-15
 NeedleHolder
 15cm,



Crile-Wood
BI-4-134-15
 NeedleHolder
 15cm,

Suture



Adson
BI-4-140-18
 Needle Holder one fenestrated jaw
 18cm,



Metzenbaum
BI-4-141-18
 Needle Holder one grooved and fenestrated
 jaw
 18.5cm,



M.G. Hospital
BI-4-142-17
 Needle Holder
 17.5cm,



Mayo-Hegar
BI-4-143-14
 Needle Holder
 14.5cm, 16cm, 18.5cm, 20.5cm, 24cm, 26.5
 cm,



Mayo-Hegar
BI-4-144-16
 Needle Holder
 16cm, 18.5cm, 20.5cm,



Brown
BI-4-145-13
 Needle Holder
 13cm, 18cm,

Suture

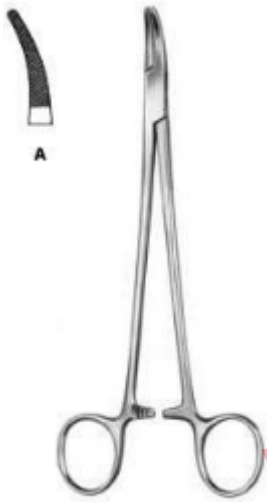

Heaney
BI-4-146-21
 NeedleHolder
 20.5cm,

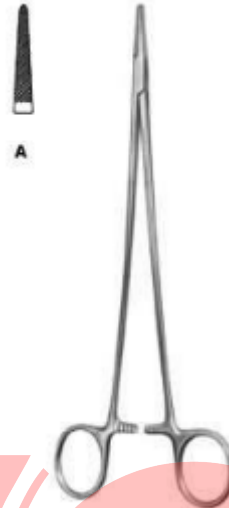

Jamison
BI-4-147-23
 NeedleHolder
 23.5cm,



Masson
BI-4-148-27
 NeedleHolder
 26.5cm,



Finochietto
BI-4-149-27
 NeedleHolder
 26.5cm,



Wangenstein
BI-4-150-27
 NeedleHolder
 26.5cm,

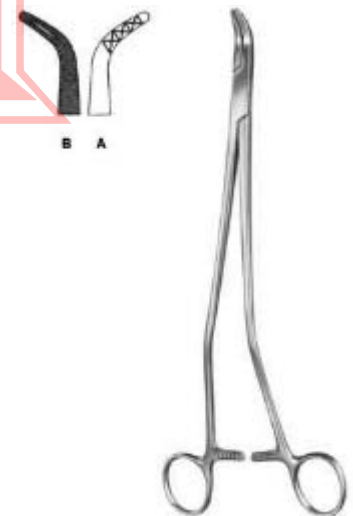

Johnson
BI-4-151-27
 NeedleHolder
 27cm,

Suture

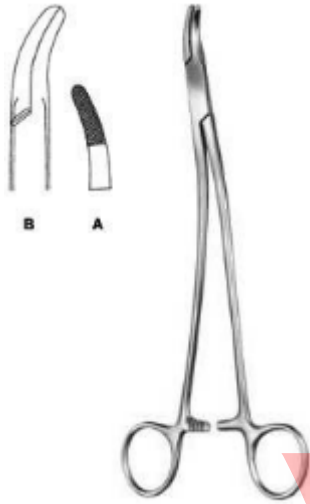

Stratte
BI-4-152-23
 NeedleHolder
 23cm,



Olsen-Hegar
BI-4-153-14
 NeedleHolder
 14cm,

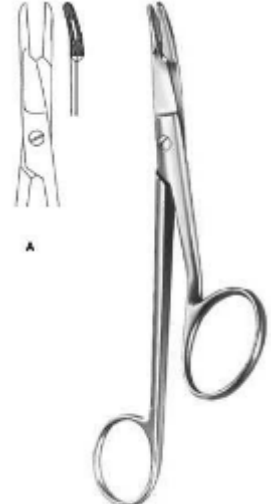

Gillies
BI-4-154-16
 NeedleHolder
 16cm,



Crile
BI-4-155-15
 NeedleHolder
 15cm,



Mathieu
BI-4-156-14
 NeedleHolder
 14cm, 17cm, 20cm,



Mathieu
BI-4-157-14
 NeedleHolder
 14cm, 16.5cm,

Suture



Toennis
BI-4-158-18
 NeedleHolder
 18.5cm,



Lichtenberg
BI-4-159-20
 NeedleHolder
 20cm,



BI-4-160-16
 MicroNeedleHolder
 16cm,



BI-4-161
 MicroNeedleHolder
 23cm, 19cm,



Hepp-Scheidel
BI-4-162-18
 MicroNeedleHolder smoothjaw
 18cm,



Webster
BI-4-163-13
 NeedleHolder with automatic releaseratchet
 also for left handers
 13cm, 15cm,

Suture



BI-4-164-15
MicroNeedleHolder
15cm, 18cm, 21cm, 23cm,



JABOMA
BI-4-165-18
MicroNeedleHolder
18cm,



Castroviejo
BI-4-166
MicroNeedleHolder
14.5cm, 18cm, 21.5cm,



Arruga
BI-4-167
NeedleHolder
16cm,



Castroviejo
BI-4-168-13
MicroNeedleHolder
12.5cm,



Barraquer
BI-4-169-13
MicroNeedleHolder
13cm,

Suture



Barraquer
BI-4-170-13
 MicroNeedleHolder
 13cm,



Webster
BI-4-171-13
 NeedleHolder
 13cm,



Derf
BI-4-173-12
 NeedleHolder
 12cm,

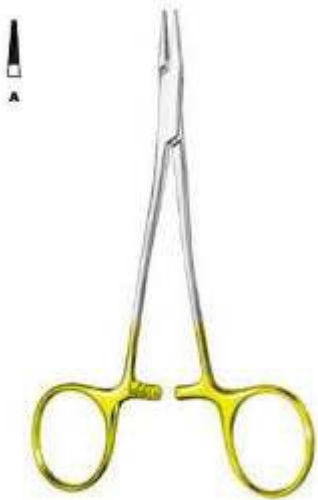

Kilner
BI-4-172-13
 NeedleHolder
 13cm,



Hegar-Baumgartner
BI-4-174-13
 NeedleHolder
 13cm, 14.5cm,



Halsey
BI-4-175-12
 NeedleHolder
 13cm, 12cm,

Suture



Crile-Wood
BI-4-176-15
 NeedleHolder
 15cm,



Sarot
BI-4-177-18
 NeedleHolder
 18cm,20cm,26cm,

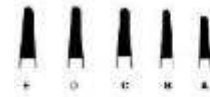

Mayo-Hegar
BI-4-178-16
 NeedleHolderstandardprofile
 16cm,18cm,20cm,24cm,26cm,30cm,



Heaney
BI-4-179-20
 NeedleHolder
 20cm,24cm,26cm,

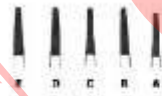

DeBakey
BI-4-180-18
 NeedleHolderdelicatepatternminiprofile
 18cm,20cm,23cm,26cm,31cm,



Masson
BI-4-181-27
 NeedleHolder
 26.5cm,

Suture



Ryder(Martin)

BI-4-182-13

NeedleHolder

12.5cm, 15cm, 18cm, 20cm, 23cm, 26cm,



Martin

BI-4-183-15

NeedleHolderminiprofileelastictype

15cm, 17cm, 20cm,



Wangensteen

BI-4-184-27

NeedleHolderstandardprofile

27cm,



Hegar-Vascular

BI-4-185-14

NeedleHoldermicroprofile

14cm, 18.5cm, 20.5cm, 23cm,

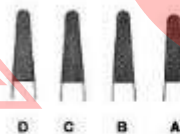

Bozemann

BI-4-186-20

NeedleHolderstandardprofile

20.5cm, 24cm, 26.5cm, 29cm,



Hegar

BI-4-187-20

NeedleHolderstandardprofile

20cm, 23.5cm,

Suture



Stratte
BI-4-188-22

NeedleHolderstandardprofile
23cm,



Microvascular
BI-4-189-00

NeedleHolderslenderpatternmicroprofile
14cm, 17.5cm, 20cm, 23cm,



Mathieu

BI-4-190-14

NeedleHolder
14cm, 17cm, 20cm,



Mathieu

BI-4-191-14

NeedleHolder
14cm, 17cm, 20cm,



Mathieu

BI-4-192-17

NeedleHolderstandardprofilewithinterior
ratchet
17cm, 20cm, 23cm,



Toennis

BI-4-193-18

NeedleHolder
18.5cm,

Suture



Lichtenberg
BI-4-194-20

NeedleHolder lightweight model standard profile
20cm,



Langenbeck
BI-4-195-18
NeedleHolder
18cm, 20.5cm, 23cm,



Zweifel
BI-4-196-20
NeedleHolder with hinged ratchet standard profile
20.5cm, 23cm,



Reverdin
BI-4-197-15

Reverdin Needle short
14.5cm Fig. 1, 14.5cm Fig. 2, 14.5cm Fig. 3, 14.5cm Fig. 4,



Reverdin
BI-4-198-19

Reverdin Needle medium
19.5cm Fig. 1, 19.5cm Fig. 2, 19.5cm Fig. 3, 19.5cm Fig. 4,



Reverdin
BI-4-199-23

Reverdin Needle long
23cm Fig. 1, 23cm Fig. 2, 23cm Fig. 3, 23cm Fig. 4,

Suture



Schmieden-Dick
BI-4-201-01
 Ligature Needle malleable
 29cm,



Schmieden
BI-4-202-21
 Ligature Needle
 24cm,



BI-4-203-20
 Ligature Needle malleable
 20.5cm,

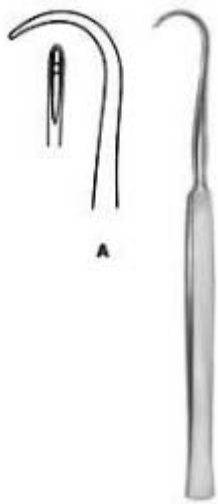

Cooper
BI-4-204-19
 Ligature Needle
 18.5cm,



Kronecker
BI-4-205-13
 Ligature Needle delicate for righthand
 12.5cm,

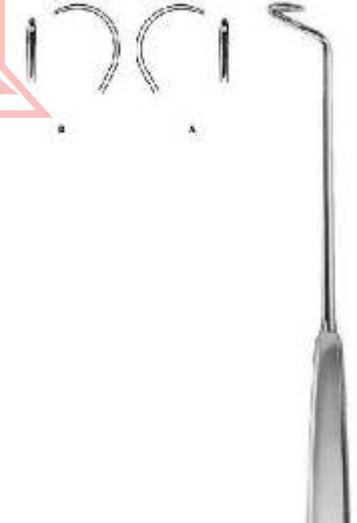

Deschamps
BI-4-206-24
 Ligature Needle blunt for righthand
 24cm,

Suture



Deschamps
BI-4-207-20
LigatureNeedlebluntforrighthand
20cm,



Deschamps
BI-4-208-20
LigatureNeedlesharpforrighthand
20cm,

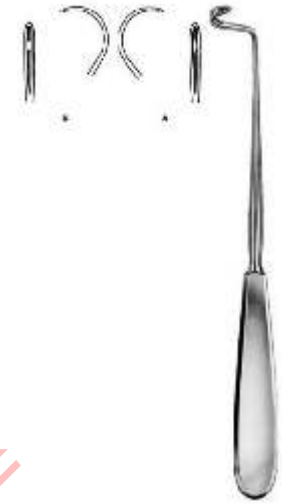

Deschamps
BI-4-209-21
LigatureNeedlebluntforrighthand
20cm,



Deschamps
BI-4-210-21
LigatureNeedlesharpforrighthand
20cm,

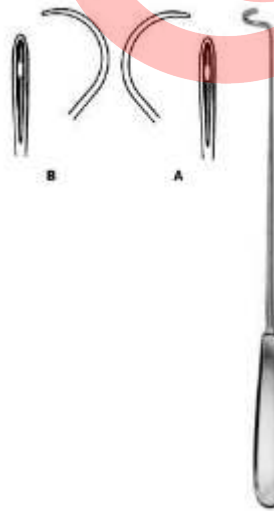

Deschamps
BI-4-211-27
LigatureNeedlebluntforrighthand
27cm,

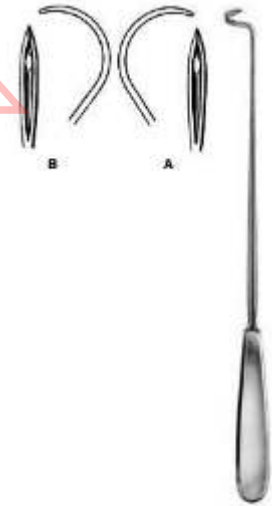

Deschamps
BI-4-212-27
LigatureNeedlesharpforrighthand
27cm,

Suture

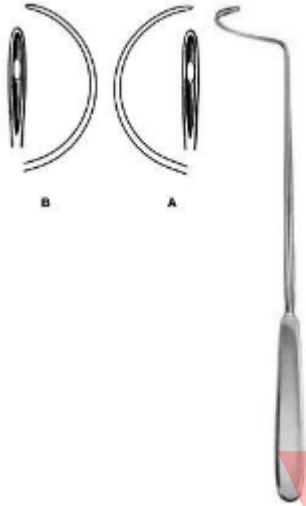

Deschamps
BI-4-213-28
Ligature Needle blunt for righthand
28cm,



Deschamps
BI-4-214-20
Ligature Needle sharp for righthand
20cm,



Deschamps
BI-4-215-20
Ligature Needle blunt for righthand
20cm,



Deschamps
BI-4-216-20
Ligature Needle blunt for righthand
21cm,

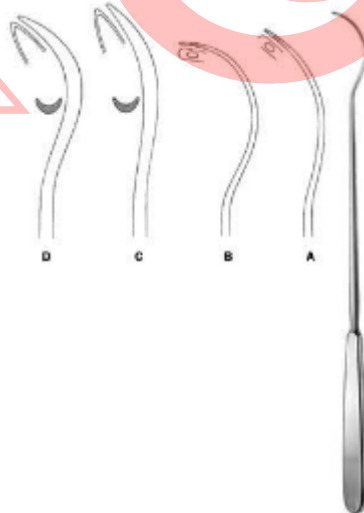

Brunner
BI-4-217-30
Ligature Needle
21cm,



Kirschner
BI-4-218-25
Ligature Conductor
25.5cm,

Suture



BI-4-219-28
LigatureConductor
28cm,



ModellWien
BI-4-220-23
LigatureCatcher
23.5cm,



Michel
BI-4-221-12
ClipApplyingForceps
12cm,



Hegenbarth
BI-4-222-12
ClipApplyingForceps
12cm,

Scalpels



BI-5-101-01

Dissecting Knife with metal handle
15cm, 15.5cm, 16cm, 17cm,



BI-5-102-10

Autopsy Knife
25.5cm,



Walb

BI-5-104-17
Post Mortem Knife



Virchow

BI-5-105-20

Brain Knife with hollow handle
28.5cm, 33.5cm, 38cm,



BI-5-108-04

Scalpel Handle solid
13.5cm,



BI-5-109-34

Scalpel Handle
16cm,

Scalpels



BI-5-110-41
Scalpel Handle solid, long
21cm,



BI-5-111-45
Scalpel Handle
21cm,



Collin
BI-5-112-08
Scalpel Handle with hollow handle
13.5cm,



Collin
BI-5-113-09
Scalpel Handle with hollow handle
14.5cm,



BI-5-114-03
Scalpel Handle solid
12cm,



BI-5-115-04
Scalpel Handle
12cm,

Scalpels



BI-5-116-05
ScalpelHandle
12cm,



BI-5-117-31
ScalpelHandle solid, long
21.5cm,



BI-5-118-35
ScalpelHandle
21cm,



BI-5-119-07
ScalpelHandle solid
16cm,



BI-5-120-71
ScalpelHandle solid short
12.5cm,



BI-5-121-03
ScalpelHandle with round hollow handle
15.5cm,

Scalpels



BI-5-127-16
Amputation Knife with hollow handle
29cm,



BI-5-128-19
Amputation Knife with hollow handle
32.5cm,



Catlin
BI-5-129-16
Interosseous Knife with hollow handle
29cm,



BI-5-130-06
Resection Knife solid handle, dissecting end
18cm,



Langenbeck
BI-5-131-05
Resection Knife
18cm,



Langenbeck
BI-5-132-05
Resection Knife
18cm,

Scalpels



BI-5-133-00

Razor knife hollow blades on both sides
cutting length 75mm



Schink

BI-5-134-00

Dermatome complete with 2 skin fixing
plates and one blade
31cm,



Schink

BI-5-135-01

Spare blades spare blade for KE-05-134-00



Schink

BI-5-136-02

Skin fixing plate for KE-05-134-00

Scissors



StandardBL/BLStraight
BI-5-201-13

OperatingScissorSpecialPrice:\$1.25
12cm,13cm,14.5cm,16.5cm,18.5cm,20.5
cm,



StandardSH/BLSTR
BI-5-202-13

OperatingScissors
12cm,13cm,14.5cm,16.5cm,18.5cm,20.5
cm,



StandardSH/SHSTR
BI-5-204-13

OperatingScissors
12cm,13cm,14.5cm,16.5cm,



StandardBL/BLCurved
BI-5-205-13

OperatingScissors
12cm,13cm,14.5cm,16.5cm,18.5cm,20.5
cm,



StandardSH/BLCurved
BI-5-206-13

OperatingScissors
12cm,13cm,14.5cm,16.5cm,18.5cm,20.5
cm,



StandardSH/SHCurved
BI-5-207-13

OperatingScissors
12cm,13cm,14.5cm,16.5cm,

Scissors



Standard BL/BLCurved
BI-5-208-14
 Operating Scissors delicate
 14.5cm,



Incision Scissor
BI-5-209-14
 Operating Scissor
 14.5cm,



Deaver
BI-5-210-14
 Operating Scissors



Mayo
BI-5-211-15
 Dissecting Scissors
 14.5cm, 15cm, 17cm, 23.5cm, 14.5cm, 15
 cm, 17cm, 23.5cm,



Mayo
BI-5-212-23
 Dissecting Scissors
 23cm, 22.5cm, 28cm,



Mayo-Harrington
BI-5-213-22
 Dissecting Scissors
 23cm, 22.5cm, 28cm,

Scissors



Mayo-Harrington
BI-5-214-22
 Dissecting Scissors cur.
 22.5cm, 28cm, 23cm,



Mayo-Stille
BI-5-215-17
 Dissecting Scissors str.
 15cm, 17cm,



Mayo-Stille
BI-5-216-15
 Dissecting Scissors cur.
 15cm, 17cm,



Mayo-Stille
BI-5-217-19
 Dissecting Scissors str.
 16cm, 19.5cm, 21.5cm,



Mayo-Stille
BI-5-218-16
 Dissecting Scissors cur.
 16cm, 19.5cm, 21.5cm,



Mayo-Noble
BI-5-219-17
 Gynecological Scissors
 16.5cm,

Scissors



Sims
BI-5-220-23
 Gynecological Scissors str.
 20cm, 23cm,



Sims
BI-5-221-20
 Gynecological Scissors cur.
 20cm, 23cm,



Kelly
BI-5-222-16
 Operating Scissors
 16cm,



Doyen
BI-5-223-17
 Gynecological Scissors
 18.5cm,



Sims-Siebold
BI-5-224-24
 Gynecological Scissors
 24.5cm,



Sims-Siebold
BI-5-225-24
 Gynecological Scissors
 24.5cm,

Scissors



Wertheim
BI-5-226-23
Gynecological Scissors
20cm, 23cm,



Metzenbaum
BI-5-227-11
Dissecting Scissors
11.5cm,



Metzenbaum
BI-5-228-14
Dissecting Scissors
14.5cm,



Metzenbaum
BI-5-229-15
Dissecting Scissors
15.5cm,



Metzenbaum-Nelson
BI-5-230-20
Dissecting Scissors
18cm, 20.5cm, 23cm, 26cm, 28.5cm, 31cm,



Metzenbaum-Nelson
BI-5-231-20
Dissecting Scissors
18cm, 20.5cm,

Scissors



Metzenbaum-Nelson
BI-5-232-20
 Dissecting Scissors
 18cm, 20.5cm, 23cm, 26cm, 28.5cm, 31cm,



Metzenbaum
BI-5-233-14
 Dissecting Scissors toothed
 14.5cm,



Nerve Operating Scissor
BI-5-234-15
 Dissecting Scissors
 15.5cm,

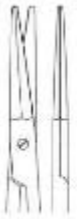

Gorney
BI-5-235-19
 Face-lift Scissors str.
 12.5cm, 19.5cm,



Gorney
BI-5-236-19
 Face-lift Scissors cur.
 19.5cm,



Aston
BI-5-237-17
 Face-lift Scissors
 17cm,

Scissors



Lexer
BI-5-238-16
Dissecting Scissors
16cm,



Cinelli
BI-5-239-14
Nasal Scissors
11.5cm, 14cm,



Thorek
BI-5-240-19
Dissecting Scissors
18.5cm,



Lexer-Baby
BI-5-241-10
Dissecting Scissors
10cm,



Lexer-Fino
BI-5-242-16
Delicate Dissecting Scissors slender pattern
16.5cm,



Metzenbaum-Fino
BI-5-243-14
Delicate Dissecting Scissors slender pattern
14.5cm,

Scissors



Metzenbaum-Fino
BI-5-244-14
Delicate Dissecting Scissors
14.5cm,



Metzenbaum-Fino
BI-5-245-14
Delicate Dissecting Scissors
14.5cm,



Metzenbaum-Fino
BI-5-246-14
Delicate Dissecting Scissors
14.5cm,

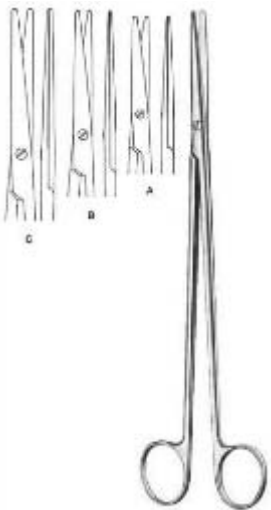

Metzenbaum-Fino
BI-5-247-18
Delicate Dissecting Scissors slender pattern
18cm, 20cm, 23cm,

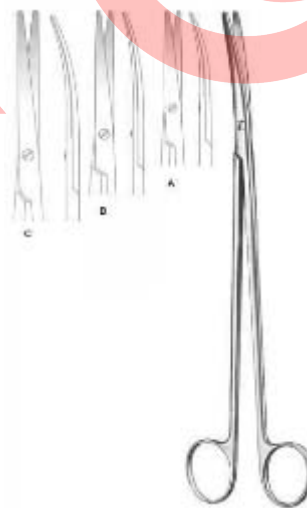

Metzenbaum-Fino
BI-5-248-18
Delicate Dissecting Scissors slender pattern
18cm, 20cm, 23cm,

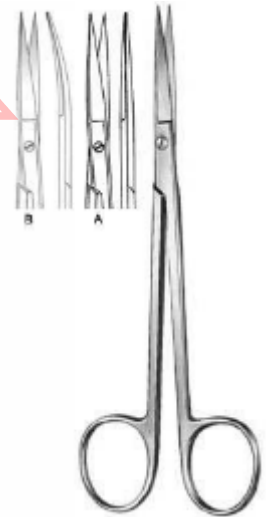

Sanvenero
BI-5-250-14
Operating Scissors
14cm,

Scissors

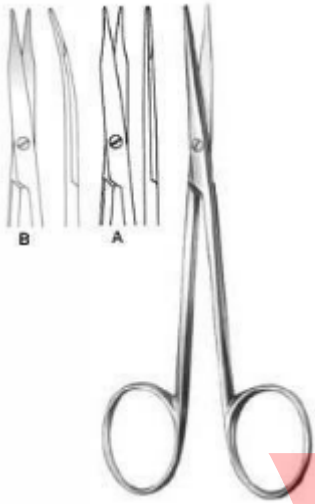

BI-5-251-11
Fine Operating Scissors
11.5cm,

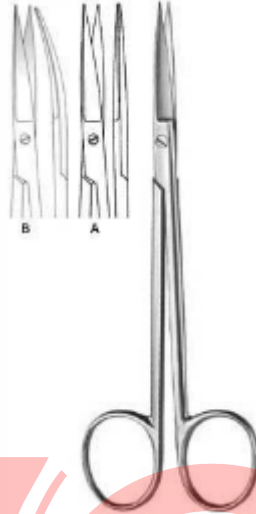

Joseph
BI-5-252-14
Operating Scissors
14.5cm,

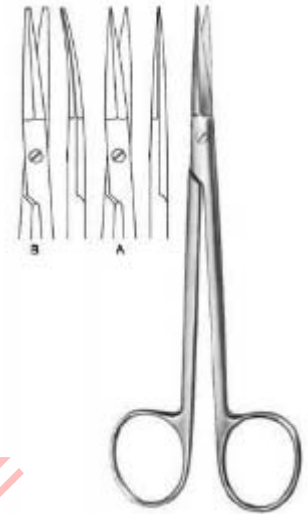

Peck-Joseph
BI-5-253-14
Face-lift Scissors
14.5cm,

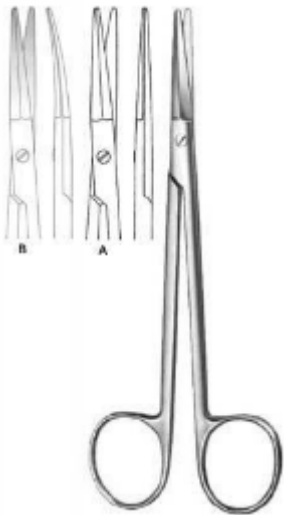

Peck-Joseph
BI-5-254-14
Face-lift Scissors
14.5cm,



Shea Vein Graft
BI-5-255-12
Dissecting Scissors
12cm,

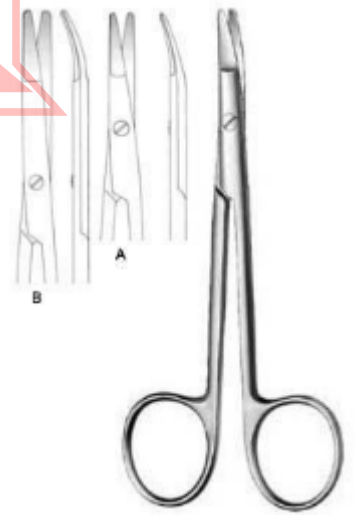

Kilner
BI-5-256-12
Dissecting Scissors
12cm, 15cm,

Scissors

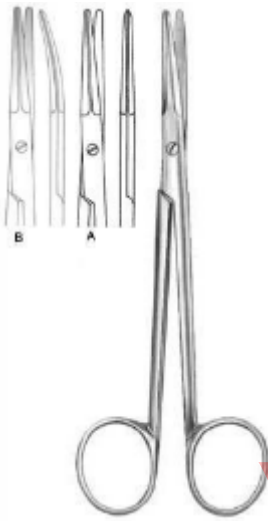

BI-5-257-14
Dissecting Scissors
14.5cm,

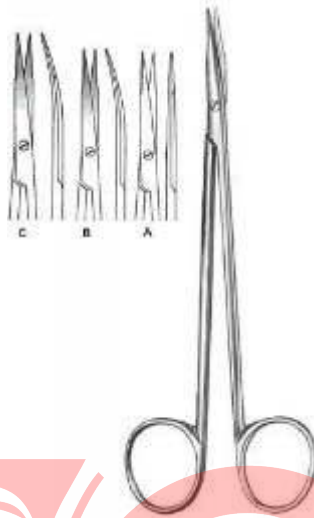

Reynolds
BI-5-258-15
Dissecting Scissors
15.5cm, 18cm,



Jameson
BI-5-259-14
Dissecting Scissors
15.5cm,



Jameson
BI-5-260-14
Dissecting Scissors
15.5cm,



BI-5-261-19
Vascular Scissors
19cm,

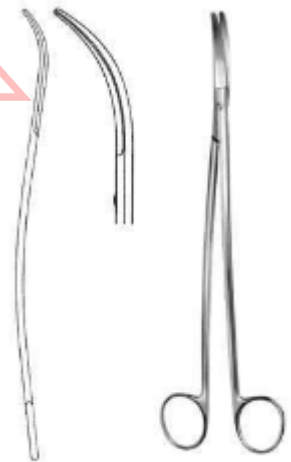

BI-5-262-24
Vascular Scissors fine, short blades
19cm, 25.5cm,

Scissors

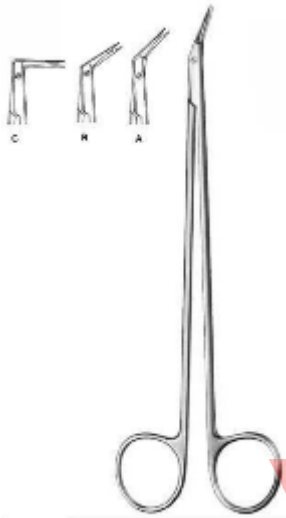

Diethrich
BI-5-263-25
 Vascular Scissors
 19cm, 18.5cm, 17.5cm,

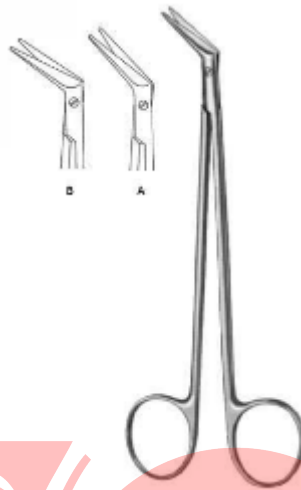

DeBakey
BI-5-264-45
 Vascular Scissors
 16.5cm, 16cm,



Potts-Smith
BI-5-265-19
 Vascular Scissors
 18cm, 18.5cm, 19cm,



Coronary Scissors
BI-5-266-25
 Cardiovascular Surgery Scissor
 18cm,



Coronary Scissors
BI-5-267-45
 Cardiovascular Surgery Scissors
 18cm,



Coronary Scissors
BI-5-268-60
 Cardiovascular Surgery Scissor
 18cm,

Scissors



Coronary Scissors

BI-5-269-90

Cardiovascular Surgery Scissor
18cm,



Coronary Scissors

BI-5-270-00

Cardiovascular Surgery Scissor
18cm,



Coronary Scissors

BI-5-271-00

Cardiovascular Surgery Scissor
18cm,



Coronary Scissors

BI-5-272-25

Cardiovascular Surgery Scissor
18cm,



Coronary Scissors

BI-5-273-45

Cardiovascular Surgery Scissor
18cm,



Coronary Scissors

BI-5-274-90

Cardiovascular Surgery Scissor
18cm,

Scissors



Schmieden-Taylor
BI-5-275-17
DuraScissors
15cm,



Strully
BI-5-276-22
NeurosurgicalScissors
22.5cm,



Toennis-Adson
BI-5-277-17
DissectingScissors
17.5cm,



Good
BI-5-279-19
TonsilScissors
19.5cm,



Fomon
BI-5-282-15
NasalScissors
15cm,



Cottle
BI-5-283-16
NasalScissors
16cm,

Scissors



Heymann
BI-5-284-18
NasalScissors
18.5cm,



Heymann
BI-5-285-18
NasalScissors
18.5cm,



Converse
BI-5-286-11
NasalScissorsblunt&sharp
10.5cm,



Waldmann
BI-5-287-18
EpisiotomyScissors
18cm,



Braun-Stadler
BI-5-288-14
EpisiotomyScissors
14.5cm,



Braun-Stadler
BI-5-289-22
EpisiotomyScissors
22cm,

Scissors



ModellUSA
BI-5-290-10
 Umbilical Scissors
 10.5cm,



Busch
BI-5-292-16
 Umbilical Scissors
 16cm,



Goldmann-Fox
BI-5-293-13
 Gum Scissors
 13cm,



Wagner
BI-5-294-12
 Operating Scissors
 12cm,

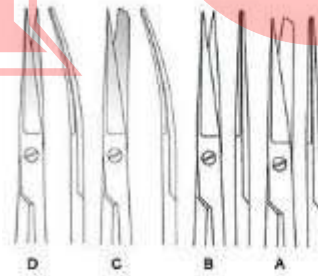

BI-5-295-12
 Operating Scissors small model
 12cm,

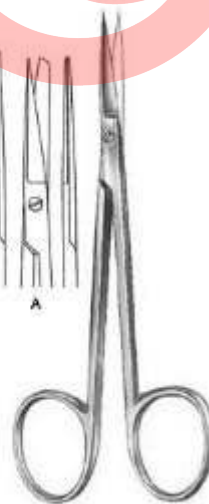

LaGrange
BI-5-296-11
 Gum Scissors S-shaped
 11.5cm,

Scissors



BI-5-297-11
Dissecting Scissors delicate
11.5cm,



Locklin
BI-5-298-16
Gum Scissors
16cm,



Locklin
BI-5-299-16
Gum Scissors
16cm,



BI-5-300-08
Operating Scissors very delicate
9cm,

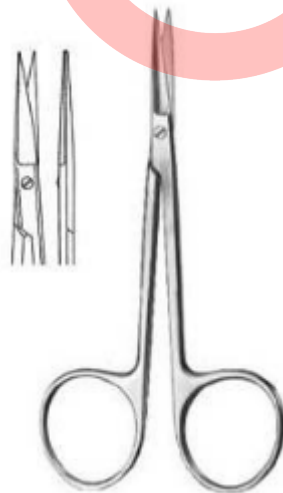

BI-5-301-10
Iris Scissors
9cm, 10cm,

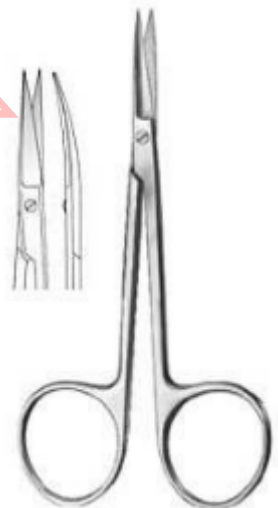

BI-5-302-10
Iris Scissors extra flat blades
10cm,

Scissors



BI-5-303-10
Iris Scissors extra flat blades
10cm,



Bonn
BI-5-304-09
Iris Scissors



Dean
BI-5-278-17
Tonsil Scissors
17.5cm,



Spencer Scissor
BI-0-

Dressing & Tissue Forceps



Standard
BI-5-401-10
Dressing Forceps
10.5cm, 11.5cm, 13cm, 14.5cm, 16cm, 18
cm, 20cm, 23cm, 25cm, 30.5cm,



Standard
BI-5-402-11
Dressing Forceps
12cm, 13cm, 14.5cm, 16cm, 18cm, 20
cm, 25cm, 30cm,



BI-5-403-13
Dressing Forceps
13cm, 14.5cm,



Stille
BI-5-404-15
Dressing Forceps
15cm,



Mini-Adson
BI-5-405-12
Dressing Forceps
12cm,



Adson
BI-5-406-12
Dressing Forceps
12cm, 15cm,

Dressing & Tissue Forceps



McIndoe
BI-5-407-15
Dressing Forceps
15cm,



Waugh
BI-5-408-20
Dressing Forceps
20cm,



Semken
BI-5-409-12
Dressing Forceps
12.5cm, 15cm,



Taylor
BI-5-410-17
Dressing Forceps
12.5cm, 15cm,



Taylor
BI-5-411-17
Dressing Forceps
17cm,



Taylor
BI-5-412-17
Dressing Forceps
18.5cm,

Dressing & Tissue Forceps



BI-5-413-06
MicroDressingForceps
15.5cm,



Gerald
BI-5-414-18
DressingForceps
15.5cm,



Cushing
BI-5-415-17
DressingForceps
17.5cm,



Potts-Smith
BI-5-416-18
DressingForceps
18cm,21cm,24.5cm,



Bonney
BI-5-417-17
DissectingForceps
17.5cm,



Gerald
BI-5-418-17
DissectingForceps
17.5cm,

Dressing & Tissue Forceps



Gillies
BI-5-419-15
Dissecting Forceps
15.5cm,



McIndoe
BI-5-420-15
Dressing Forceps
15cm,



Semken
BI-5-421-16
Dissecting Forceps
15.5cm, 17.5cm,



Adson-Brown
BI-5-422-12
Dissecting Forceps
12cm,



Adson
BI-5-423-12
Dissecting Forceps
12cm, 15cm,



Adson
BI-5-424-12
Dressing Forceps
12cm, 15cm,

Dressing & Tissue Forceps



Cushing
BI-5-425-17
 Dressing Forceps
 17.5cm,



Cushing
BI-5-426-18
 Dressing Forceps
 17cm,



Cushing-Taylor
BI-5-427-18
 Dressing Forceps
 18.5cm,



Potts-Smith
BI-5-428-15
 Dressing Forceps
 16cm, 18.5cm, 20cm, 23cm, 25cm,



Oehler
BI-5-429-14
 Dissecting Forceps
 14.5cm, 16cm, 18cm, 20cm, 25cm,



Wangensteen
BI-5-430-15
 Dressing Forceps
 15cm, 23cm,

Dressing & Tissue Forceps



**DeBakey
BI-5-431-15**

Atraumatic Dressing Forceps
16cm, 20cm, 24.5cm, 16cm, 20cm, 24.5cm,



**DeBakey
BI-5-432-16**

Atraumatic Dressing Forceps
16cm, 20cm, 24cm,



BI-5-433-10

Dissecting Forceps
10.5cm, 11.5cm, 13cm, 14.5cm, 16cm, 18cm, 20cm, 23cm, 25cm, 30.5cm,

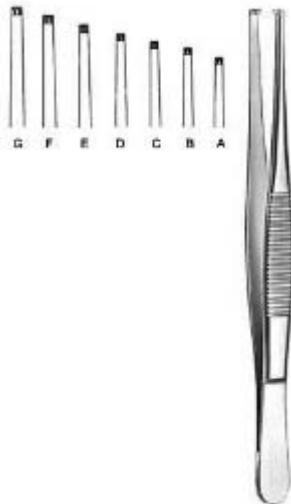

BI-5-434-11

Dissecting Forceps
12cm, 13cm, 14.5cm, 15.5cm, 18cm, 20cm, 24.5cm,



BI-5-435-14

Dissecting Forceps
14.5cm, 16cm,



BI-5-436-14

Dissecting Forceps
14.5cm, 16cm,

Dressing & Tissue Forceps



BI-5-437-13
Dissecting Forceps
13cm, 14.5cm, 16cm, 20cm,



BI-5-438-13
Dissecting Forceps
13cm, 14.5cm,



Stille
BI-5-439-15
Dissecting Forceps
15cm,



Stille
BI-5-440-15
Dissecting Forceps
15cm,



Stone
BI-5-441-15
Dissecting Forceps
15cm,



Lerche
BI-5-442-15
Dissecting Forceps
15cm,

Dressing & Tissue Forceps



Adlerkreutz
BI-5-443-15
 Dissecting Forceps
 15.5cm, 20.5cm, 16cm, 20cm, 25cm,

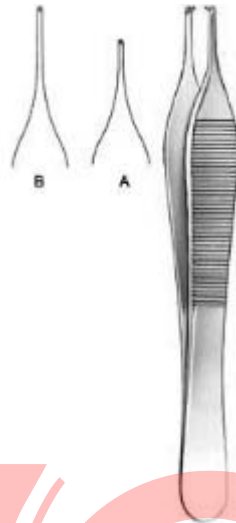

Adson
BI-5-444-12
 Dissecting Forceps
 12cm, 15cm,



Gillies
BI-5-445-15
 Dissecting Forceps
 15.5cm,



Waugh
BI-5-446-20
 Dissecting Forceps
 20.5cm,



Semken
BI-5-447-12
 Dissecting Forceps
 12.5cm, 15cm,



Taylor
BI-5-448-17
 Dissecting Forceps
 17.5cm,

Dressing & Tissue Forceps



Taylor
BI-5-449-17
 Dissecting Forceps
 17cm,



Taylor
BI-5-450-17
 Dissecting Forceps
 18.5cm,



BI-5-451-06
 MicroDissecting Forceps
 15.5cm,



Gerald
BI-5-452-17
 Dissecting Forceps
 17.5cm,



Cushing
BI-5-453-17
 Dissecting Forceps
 18cm,



Potts-Smith
BI-5-454-18
 Dissecting Forceps
 18cm, 21cm, 24cm,

Dressing & Tissue Forceps

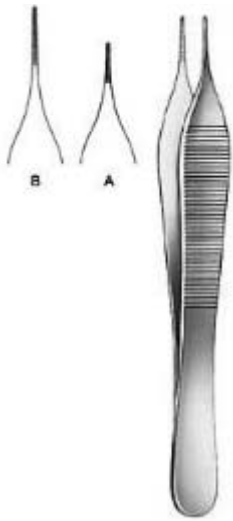

Mikro-Adson
BI-5-455-12
 Dressing Forceps
 12cm, 15cm,

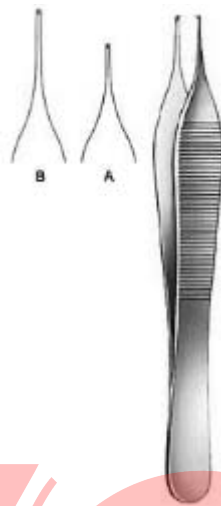

Mikro-Adson
BI-5-456-12
 Dissecting Forceps
 12cm, 15cm,



BI-5-457-11
 Dissecting Forceps
 10.5cm,



Micro Jewelers
BI-5-458-12
 Jeweler Type Forceps
 12cm Fig.7,



Jewelers
BI-5-459-12
 Jeweler Type Forceps
 12cm Fig.3,



Jewelers
BI-5-460-11
 Jeweler Type Forceps
 11cm Fig.3c,

Dressing & Tissue Forceps



Jewelers
BI-5-461-11
JewelerTypeForceps
11cmFig.5,



Jewelers
BI-5-462-11
JewelerTypeForceps
11cmFig.4,



Stille-Barraya
BI-5-463-18
DissectingForceps
18cm,



Bonney
BI-5-464-18
DissectingForceps
17.5cm,



Nelson
BI-5-465-23
DissectingForceps
23cm,



BI-5-466-10
DressingForceps
10cm,9.5cm,

Dressing & Tissue Forceps



BI-5-467-12
Splinter Forceps smooth jaw
12.5cm,



BI-5-468-12
Splinter Forceps smooth jaw
12.5cm,



BI-5-469-12
Splinter Forceps
12.5cm,



BI-5-470-12
Splinter Forceps
12.5cm,



BI-5-471-16
Micro Tying Forceps
15.5cm,



BI-5-472-10
Microscopic Forceps superlight, blunt
10cm,

Dressing & Tissue Forceps



BI-5-473-10
Microscopic Forceps
10cm,



Shaaf
BI-5-474-09
Splinter Forceps
9.5cm,



Littauer
BI-5-475-08
Cilia Forceps
8.5cm,



BI-5-476-09
Cilia Forceps
8.5cm,



Douglas
BI-5-477-09
Cilia Forceps
9cm,



Douglas
BI-5-478-09
Cilia Forceps
9cm,

Dressing & Tissue Forceps



Beer
BI-5-479-09
CiliaForceps
9cm,

Splinter Forceps



Phaneuf
BI-5-501-21
 Hysterectomy Forceps
 20.5cm,



Wertheim-Cullen
BI-5-502-21
 Vaginal Clamp
 21cm,

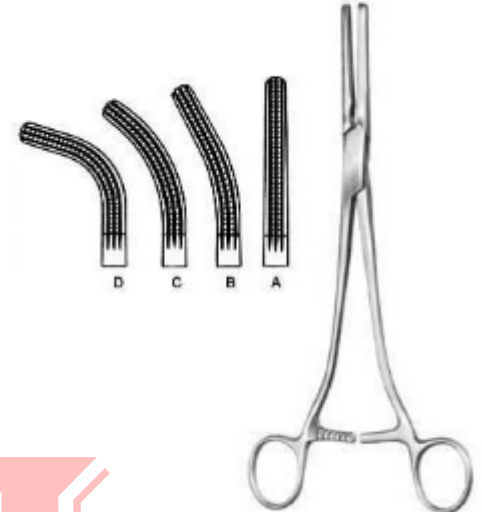

Rogers
BI-5-503-10
 Hysterectomy Forceps
 21.5cm Fig.1, 21cm Fig.2, 20.5cm Fig.3, 20cm Fig.4,



Moynihan
BI-5-504-23
 Hysterectomy Forceps
 23cm,



Moynihan
BI-5-505-24
 Hysterectomy Forceps
 23.5cm,



Wertheim
BI-5-506-25
 Hysterectomy Forceps
 26cm,

Splinter Forceps

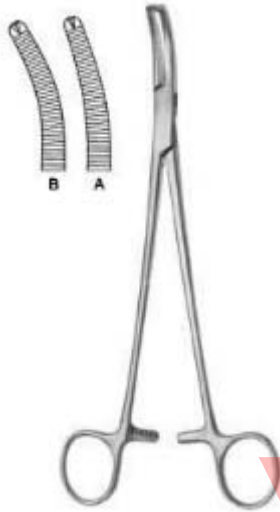

Wertheim
BI-5-507-22
 Hysterectomy Forceps
 22.5cm,



Mikulicz, Baby
BI-5-508-14
 Peritoneum Forceps
 14.5cm,



Mikulicz
BI-5-509-18
 Peritoneum Forceps
 20.5cm,



Mikulicz
BI-5-510-20
 Peritoneum Forceps
 18.5cm,



Mikulicz
BI-5-511-20
 Peritoneum Forceps
 20cm,



Mikulicz
BI-5-512-21
 Peritoneum Forceps
 20.5cm,

Splinter Forceps



Faure
BI-5-513-20
Peritoneum Forceps
21cm,

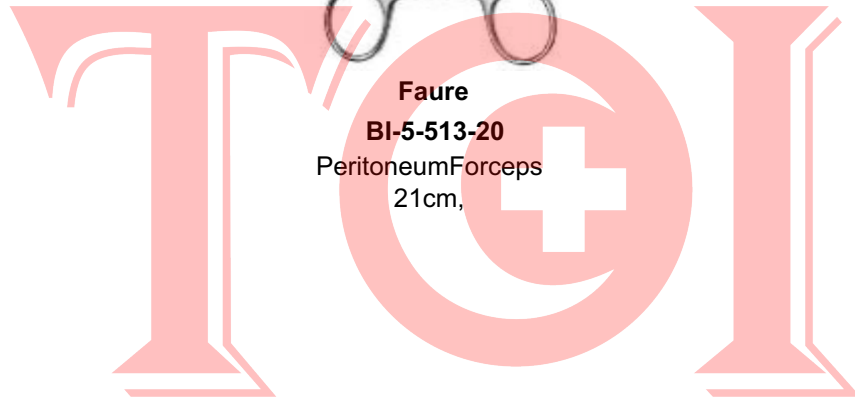

Haemostatic Forceps

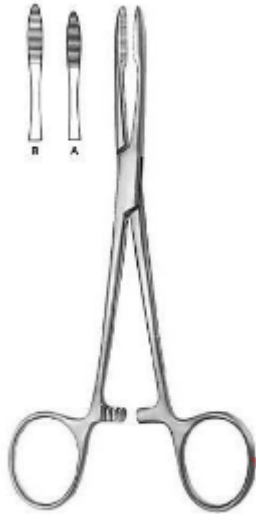

Pean
BI-5-601-14
 Haemostatic Forceps
 14.5cm, 16cm,



Spencer-Wells
BI-5-602-13
 Haemostatic Forceps
 13cm, 14cm, 15.5cm, 18.5cm, 20cm,



Spencer-Wells
BI-5-603-13
 Haemostatic Forceps
 13cm, 14cm, 15cm, 18cm, 20cm,



Chaput
BI-5-604-13
 Haemostatic Forceps
 12.5cm,



Tuffier
BI-5-605-13
 Haemostatic Forceps
 12.5cm,

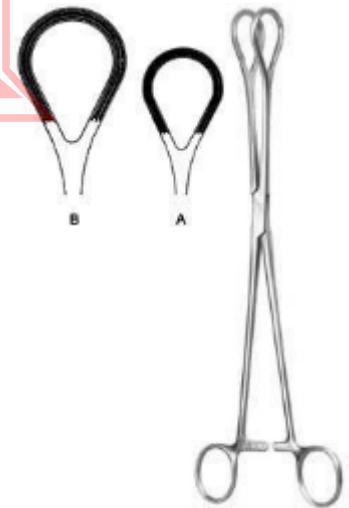

BI-5-606-25
 Organ Grasping Forceps

Haemostatic Forceps



Collin
BI-5-607-14
 Organ Grasping Forceps
 15.5cm, 21cm,



Collin
BI-5-608-17
 Tumor Grasping Forceps
 17cm,



Pennington
BI-5-609-15
 Haemostatic Forceps
 15.5cm,



Pratt
BI-5-610-15
 Haemostatic Forceps
 15cm,



Martel-Rees
BI-5-611-14
 Face-lift Forceps
 13.5cm,



BI-5-612-12
 Ligature Forceps

Haemostatic Forceps



Mixer-Baby
BI-5-613-01
 Dissecting and Ligature Forceps
 13.5cm, 13cm,

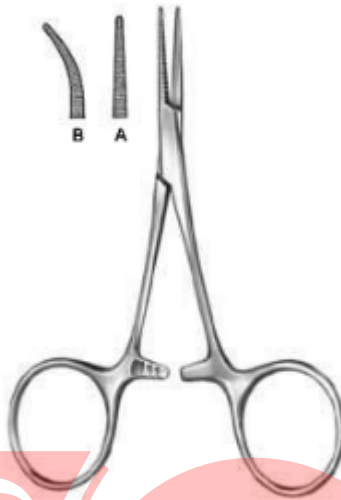

Hartmann
BI-5-614-10
 Haemostatic Forceps
 10cm, 9.5cm,



BI-5-615-12
 Ligature Forceps

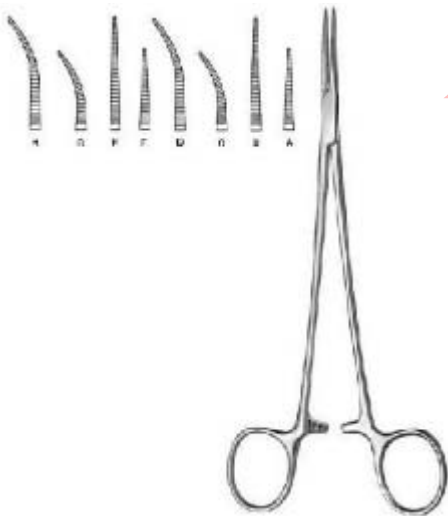

Halsted-Mosquito
BI-5-616-18
 Haemostatic Forceps
 12.5cm, 14.5cm, 14cm,



Mikro-Mosquito
BI-5-617-10
 Haemostatic Forceps
 10cm, 12cm, 9.5cm, 11.5cm,



Providence-Hospital
BI-5-618-14
 Haemostatic Forceps
 14cm,

Haemostatic Forceps



Leriche
BI-5-619-15
 Haemostatic Forceps
 15.5cm, 15cm,

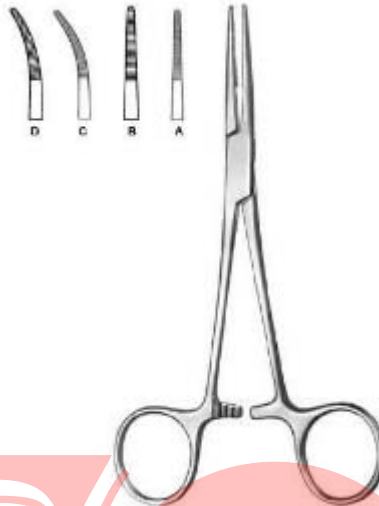

Kelly
BI-5-620-14
 Haemostatic Forceps
 14.5cm, 14cm,



Kelly-Rankin
BI-5-621-16
 Haemostatic Forceps
 16cm, 15.5cm,



Overholt-Baby
BI-5-622-14
 Dissecting and Ligature Forceps
 14.5cm, 14cm,



Crile
BI-5-623-14
 Haemostatic Forceps
 14.5cm, 14cm,



Crile-Rankin
BI-5-624-16
 Haemostatic Forceps
 16.5cm, 16cm,

Haemostatic Forceps



Lovelace
BI-5-625-15
 Haemostatic Forceps
 16cm,



Dandy-Mosquito
BI-5-626-12
 Haemostatic Forceps
 12cm,



Dandy
BI-5-627-14
 Haemostatic Forceps
 14.5cm, 14cm,



Schmidt
BI-5-628-18
 Dissecting and Ligature Forceps
 18.5cm, 19cm,



Adson
BI-5-629-18
 Dissecting and Ligature Forceps
 19cm, 18.5cm,



Martin-Fuchsig
BI-5-630-20
 Dissecting and Ligature Forceps
 20.5cm,

Haemostatic Forceps

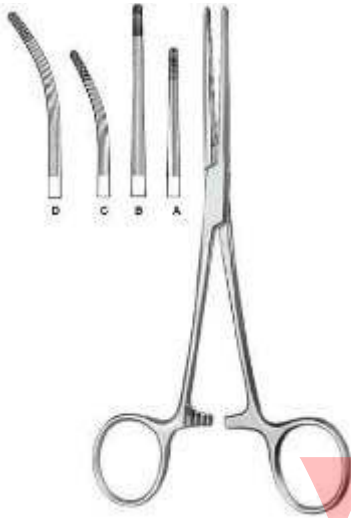

Rochester-Carmalt
BI-5-631-16

Haemostatic Forceps
17cm, 20.5cm, 16.5cm, 20cm,

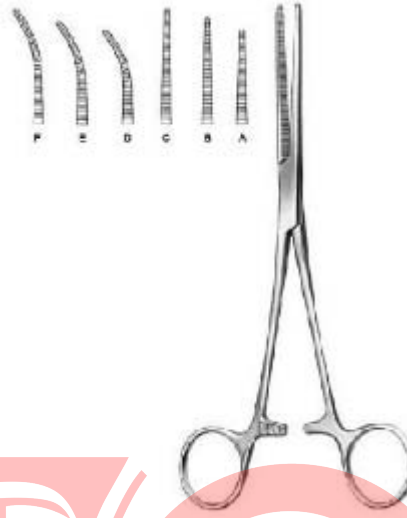

Pean

BI-5-632-13

Haemostatic Forceps
13.5cm, 14.5cm, 17cm, 13cm, 14cm, 16.5
cm,

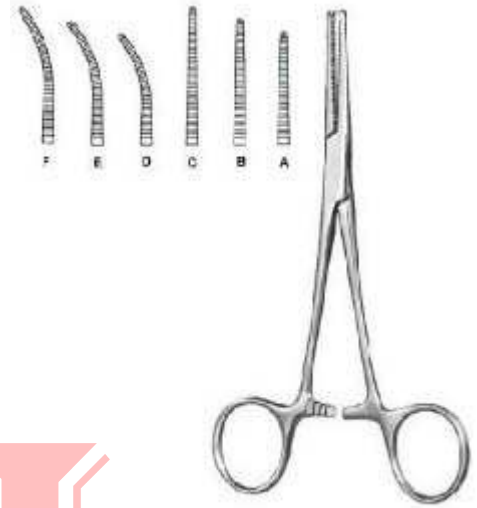

Kocher-Nippon

BI-5-633-14

Haemostatic Forceps
14.5cm, 16.5cm, 18.5cm, 16cm, 18cm,

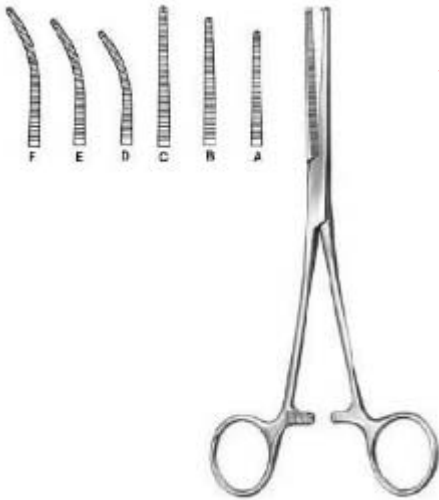

Kocher

BI-5-635-13

Haemostatic Forceps
13cm, 14cm, 16cm,

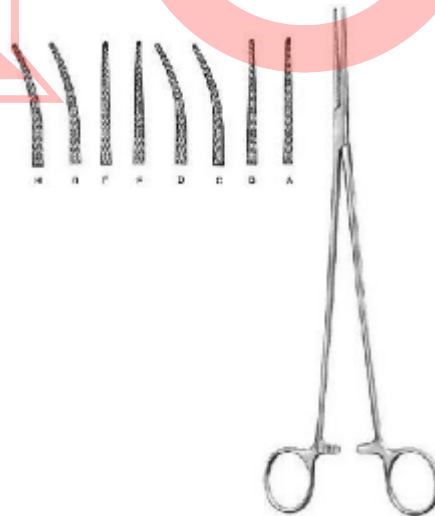

Bengolea

BI-5-636-20

Haemostatic Forceps
21.5cm, 26cm, 21cm, 21.5cm,

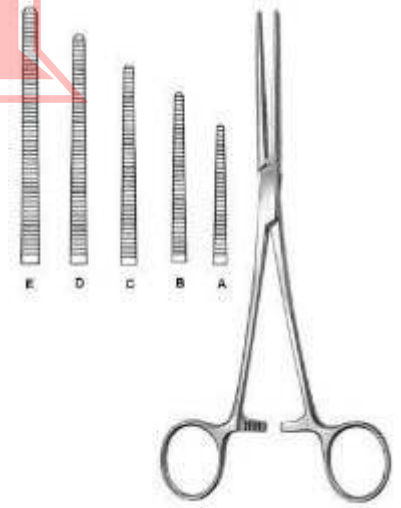

Pean (Rochester)

BI-5-637-14

Haemostatic Forceps
14.5cm, 16.5cm, 18.5cm, 20.5cm, 22.5
cm, 24.5cm, 26cm, 30.5cm, 14cm, 16cm,

Haemostatic Forceps

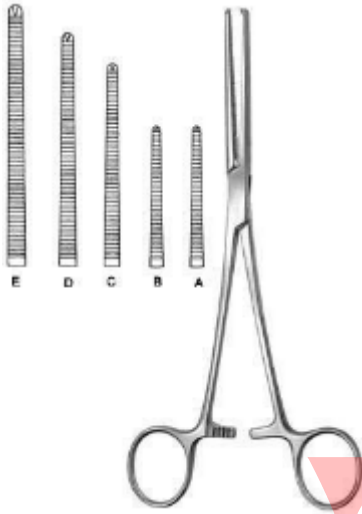

Kocher(Ochsner)
BI-5-638-14

Haemostatic Forceps
14.5cm, 16.5cm, 18.5cm, 20.5cm, 22.5cm, 24.5cm, 26cm, 30.5cm,

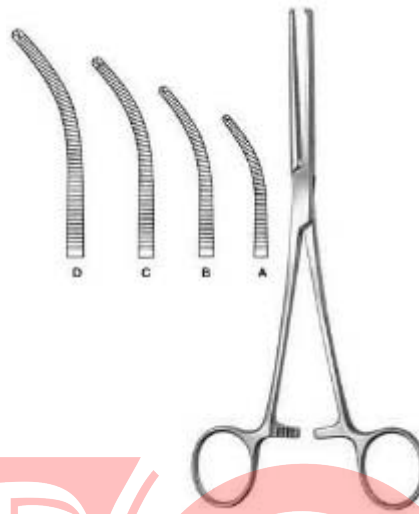

Kocher(Ochsner)
BI-5-639-14

Haemostatic Forceps
14cm, 16cm, 18cm, 20cm, 22cm, 24cm, 25.5cm, 30cm,

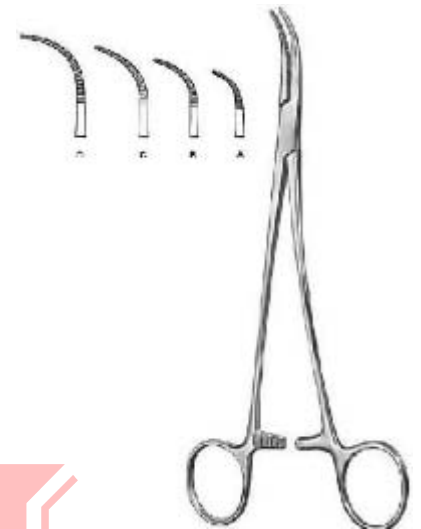

Overholt-Martin
BI-5-640-01

Dissecting and Ligature Forceps
18.5cm Fig.1, 20.5cm Fig.2, 21cm Fig.3, 21.5cm Fig.4, 24.5cm Fig.5,



Mixter-Baby
BI-5-641-18

Dissecting and Ligature Forceps
18.5cm,



Adson-Baby
BI-5-642-14

Dissecting and Ligature Forceps
14.5cm, 18cm,



Heiss
BI-5-643-20

Dissecting and Ligature Forceps
21cm, 20.5cm, 20cm,

Haemostatic Forceps



Overholt-Mixer
BI-5-644-21

Dissecting and Ligature Forceps
21.5cm,

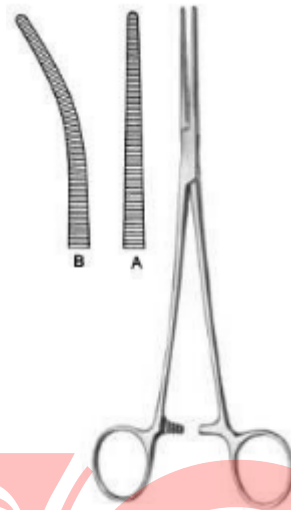

Roberts
BI-5-645-22

Dissecting and Ligature Forceps
22.5cm, 21.5cm,

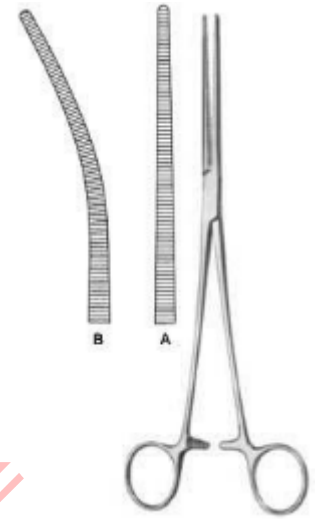

Sarot

BI-5-646-24

Dissecting and Ligature Forceps
25cm, 24.5cm,

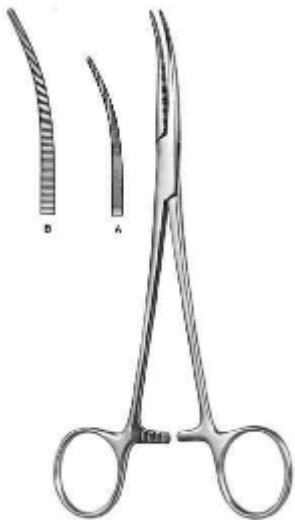

Crafoord
BI-5-647-18

Dissecting and Ligature Forceps
18cm, 24.5cm,

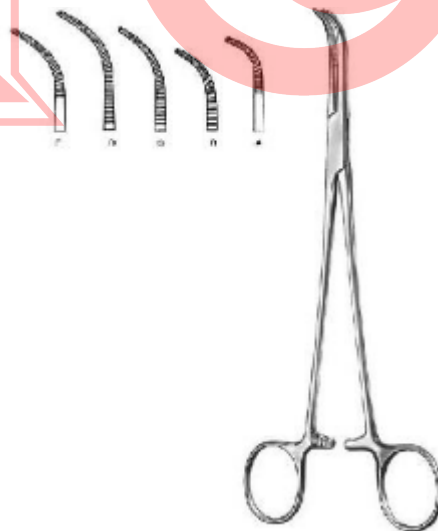

Overholt-Geissendorfer
BI-5-648-01

Dissecting and Ligature Forceps
20.5cm Fig. 1, 20cm Fig. 2, 21.5cm Fig.
3, 22cm Fig. 4, 21.5cm Fig. 5, 22cm Fig.
6, 27cm Fig. 1, 26.5cm Fig. 2, 27.5cm Fig.
3, 28cm Fig. 4,

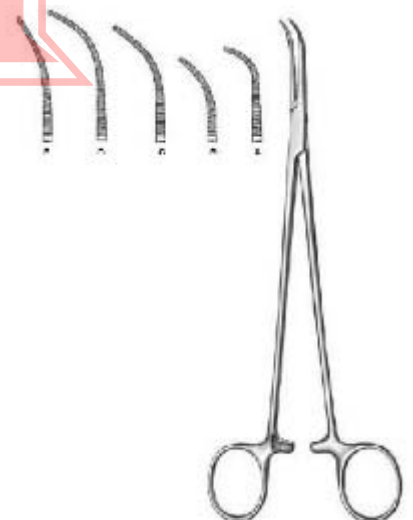

Overholt-Fino
BI-5-649-00

Dissecting and Ligature Forceps
21.5cm, 21cm, 22cm, 23cm, 22.5cm,

Haemostatic Forceps

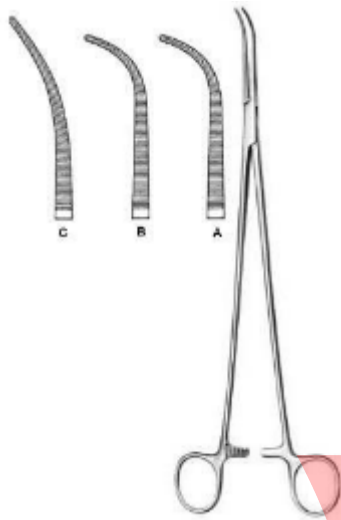

Overholt
BI-5-650-00

Dissecting and Ligature Forceps
29.5cm, 30cm,



Overholt-Mini
BI-5-651-01

Dissecting and Ligature Forceps
15cm, 20cm,



Gemini

BI-5-652-13

Dissecting and Ligature Forceps
13cm, 16cm, 18cm, 21cm, 23cm, 25cm, 28cm,



Mini-Gemini
BI-5-653-18

Dissecting and Ligature Forceps
18cm, 22.5cm, 25cm, 28.5cm,

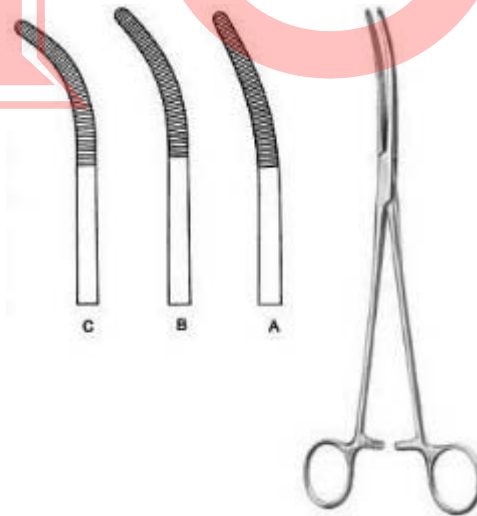

Rumel

BI-5-654-01

Dissecting and Ligature Forceps
24cm Fig.1, 23.5cm Fig.2, 23cm Fig.3, 24cm Fig.4, 23.5cm Fig.5,

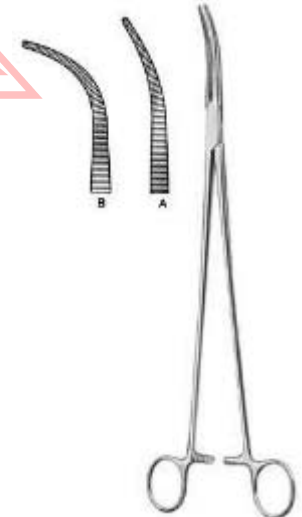

Zenker

BI-5-655-01

Dissecting and Ligature Forceps
29.5cm, 28.5cm,

Haemostatic Forceps



Mixer-Baby
BI-5-656-14
 Dissecting and Ligature Forceps
 13.5cm,



Mixer
BI-5-657-15
 Dissecting and Ligature Forceps
 16cm, 18cm,



Mixer-O'Shaughnessy
BI-5-658-19
 Dissecting and Ligature Forceps
 18cm,



Mixer
BI-5-659-22
 Dissecting and Ligature Forceps
 22.5cm,



Mixer
BI-5-660-23
 Dissecting and Ligature Forceps
 23cm,



Wickstrom
BI-5-661-21
 Dissecting and Ligature Forceps
 21cm, 24.5cm,

Haemostatic Forceps



Mixer

BI-5-662-22

Dissecting and Ligature Forceps
22.5cm, 26cm, 28cm,



McQuigg-Mixer

BI-5-663-22

Dissecting and Ligature Forceps
23.5cm,



Lower

BI-5-664-18

Dissecting and Ligature Forceps
18.5cm,



Lahey

BI-5-665-19

Bile Duct Clamp
19.5cm, 22.5cm,



Finochietto

BI-5-666-24

Dissecting and Ligature Forceps
24cm,

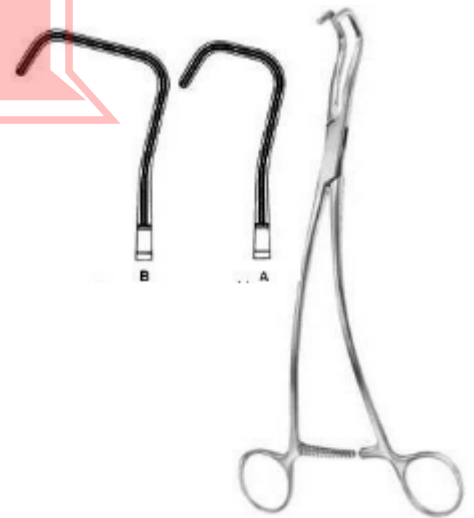

Uro-Tangential

BI-5-667-01

Tangential Forceps
25cm, 27cm,

Haemostatic Forceps

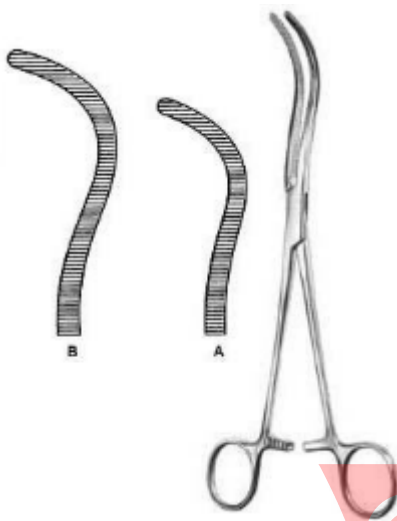

Guyon
BI-5-668-20
 Kidney Pedicle Clamp
 23cm, 24cm,



Guyon
BI-5-669-23
 Kidney Pedicle Clamp
 19.5cm, 21.5cm, 24cm,



Desjardins
BI-5-670-21
 Bile Duct Clamp
 21cm,

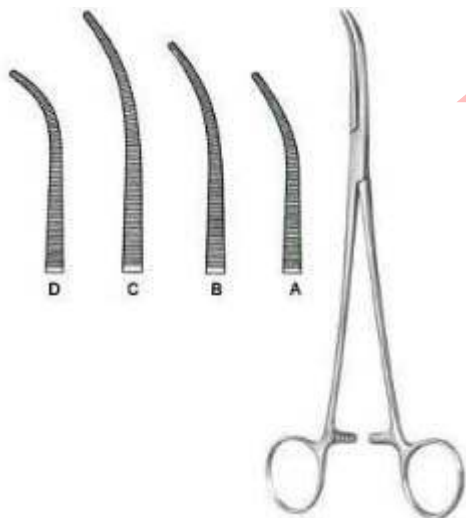

Kelly
BI-5-671-19
 Dissecting and Ligature Forceps
 19.5cm Fig. 1, 22.5cm Fig. 1, 24.5cm Fig.
 1, 19cm Fig. 2, 22cm Fig. 2, 24cm Fig.
 2, 18.5cm Fig. 3, 21.5cm Fig. 3, 23.5cm Fig.
 3,



Lawrence
BI-5-672-28
 Dissecting and Ligature Forceps
 28cm,



Meeker
BI-5-673-28
 Dissecting and Ligature Forceps
 28cm,

Haemostatic Forceps



Negus
BI-5-674-19
Haemostatic Forceps
19.5cm Fig. 1, 20cm Fig. 2,

Towel & Tubing Clamps



Schaedel
BI-5-701-09
 TowelClampsharp
 9cm,



Jones
BI-5-702-05
 TowelClampsharp
 5.5cm,8.5cm,



Jones-Martin
BI-5-703-09
 TowelClampsharp
 8.5cm,

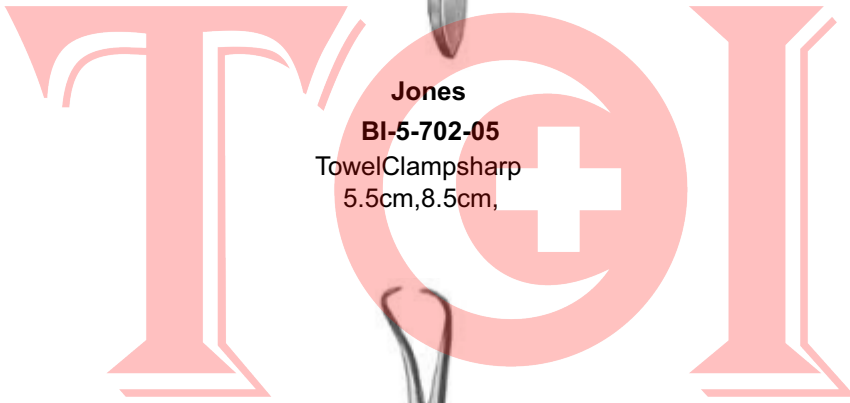

Backhaus
BI-5-704-11
 TowelClamp
 11.5cm,13cm,



Backhaus
BI-5-705-11
 TowelClamp
 11.5cm,



Backhaus
BI-5-706-08
 TowelClamp
 9cm,11.5cm,13cm,16cm,

Towel & Tubing Clamps



Peers-Bertram modif.
BI-5-707-15
 Towel Clamp wide jaw for tube fixation
 15.5cm,



R?der
BI-5-708-13
 Towel Clamp
 13.5cm,

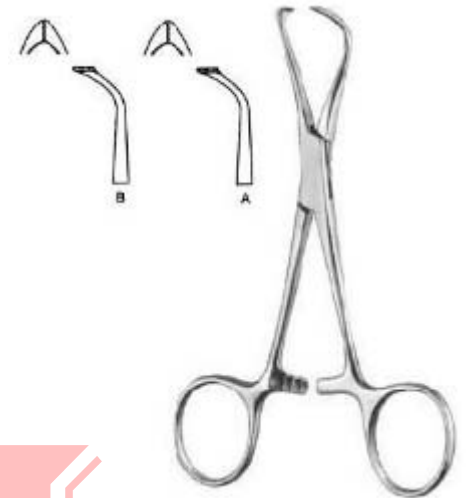

Lorna
BI-5-709-10
 Towel Clamp fine serrated, wide jaw
 9.5cm, 13cm,



Bernhard
BI-5-710-16
 Towel Clamp
 16.5cm,

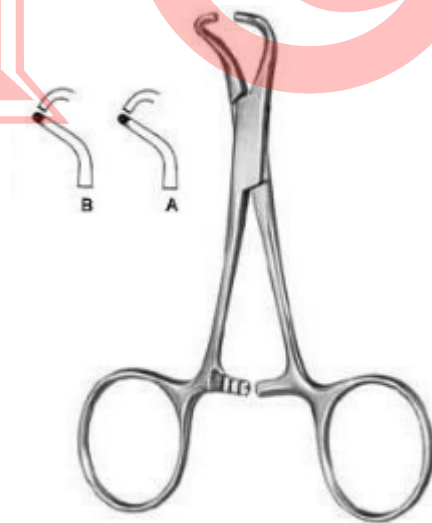

Tohoku
BI-5-711-10
 Towel Clamp
 10.5cm blunt, 13.5cm blunt, 14.5cm,

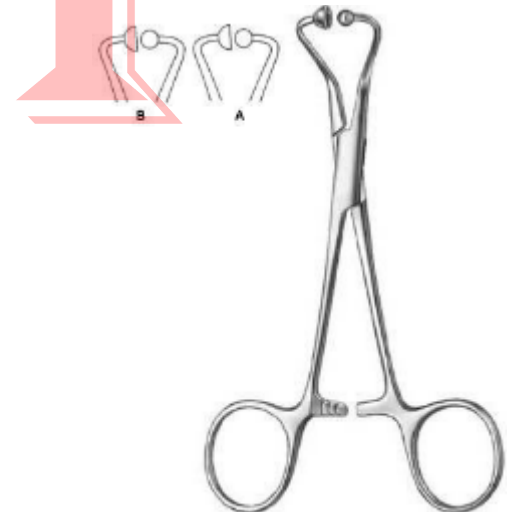

BI-5-712-11
 Towel Clamp for paper clothes
 11.5cm, 14cm,

Towel & Tubing Clamps



Lane
BI-5-713-20
Towel Clamp
19.5cm,



BI-5-714-06
Tube Holder for fixation of six tubes



BI-5-715-14
Tubing Clamp with extralong ratchet
14cm,



BI-5-716-16
Tubing Clamp
16.5cm,



BI-5-717-15
Tubing Clamp
15.5cm, 19cm, 20.5cm,



BI-5-718-15
Tubing Clamp with safety guard
15.5cm, 19cm, 20.5cm,

Dressing & Sponge Forceps



Ulrich

BI-5-801-22

Dressing Forceps
22.5cm, 26.5cm,



Lister

BI-5-802-13

Sinus Forceps
13cm, 16cm, 18cm,



Martin

BI-5-803-17

Dressing Forceps
17.5cm, 17cm,

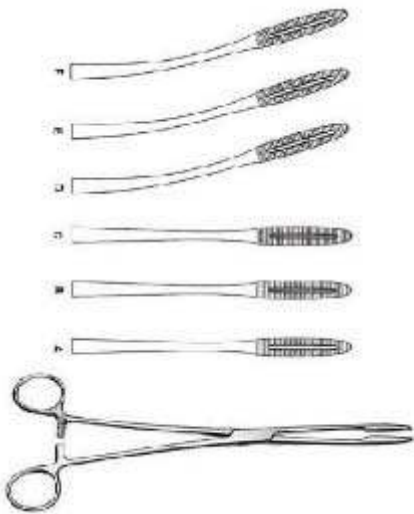

Gross-Maier

BI-5-804-20

Dressing Forceps
20.5cm, 22cm, 26.5cm, 20cm, 21.5cm, 26
cm,



BI-5-805-40

Tunneling Forceps
39.5cm,



Collin

BI-5-806-25

Dressing Forceps
25.5cm,

Dressing & Sponge Forceps



Cheron
BI-5-807-25
Dressing Forceps
23.5cm,



Bozemann
BI-5-808-26
Sponge Forceps
26cm,

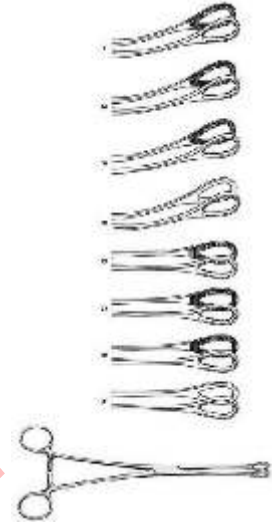

Foerster
BI-5-809-25
Sponge Forceps
25cm, 18cm, 20.5cm, 24.5cm, 17.5cm, 20cm, 24.5cm,

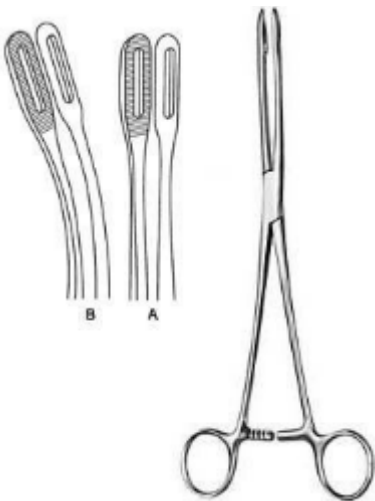

Foerster
BI-5-810-25
Sponge Forceps
25cm, 24.5cm,



Rampley
BI-5-811-18
Sponge Forceps
18.5cm, 24.5cm,

Retractors



Vickers
BI-5-901-18
 SkinHooklet
 18.5cm,



Vickers
BI-5-902-01
 BoneHooklet
 17cm,



Vickers
BI-5-903-01
 TendonHooklet
 17cm,



Vickers
BI-5-904-02
 Hooklet
 16cm,

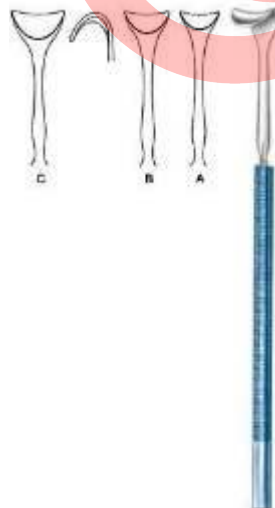

Vickers
BI-5-905-12
 SaddleHook
 14cm,



Graefe
BI-5-906-01
 MicroHooklet
 15cm,

Retractors

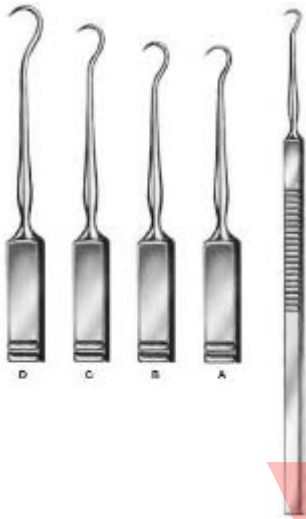

BI-5-907-01
SkinHook
16cmFig.1,16cmFig.2,16cmFig.3,16
cmFig.4,



OConnor
BI-5-908-16
SkinHook
16cm,



Guthrie
BI-5-909-01
SkinHook
15.5cm,

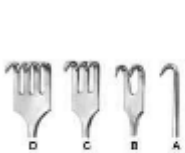

BI-5-910-01
Hooklet
16.5cm,

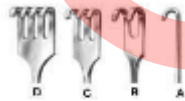

BI-5-911-01
Hooklet
16.5cm,

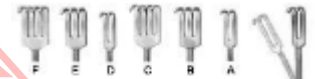

BI-5-912-02
Hooklet
16cm,

Retractors



BI-5-913-04
Hooklet
16.5cm,



BI-5-914-12
VesselHook
12cm,



Desmarres
BI-5-915-08
SaddleHook
16cm8mm, 16cm10mm, 16cm12mm, 16cm14mm, 16cm16mm, 16cm18mm,

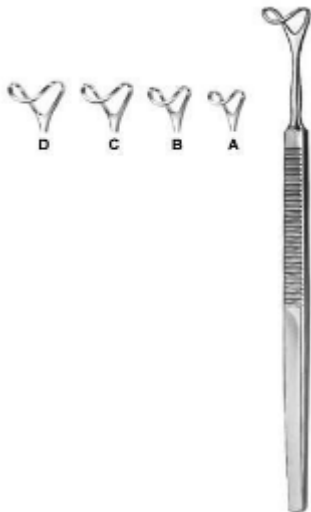

BI-5-916-12
SaddleHook
16cm12mm, 16cm14mm, 16cm16mm, 16cm18mm,



Langenbeck-Mini
BI-5-917-10
Hooklet
16cm,



BI-5-918-16
Hooklet
16cm14x8,

Retractors

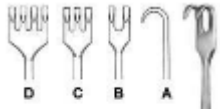

BI-5-919-01
Hooklet
16.5cm,



BI-5-920-01
Hooklet
16.5cm,



Meyerding
BI-5-921-01
Hooklet
17.5cmFig.1,17.5cmFig.2,17.5cmFig.3,17.5cmFig.4,17.5cmFig.5,17.5cmFig.6,



Senn-Green
BI-5-922-01
Hooklet
15cmFig.1,15cmFig.2,



Ragnell-Davis
BI-5-923-14
Hooklet
14cm,

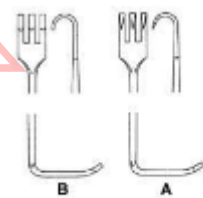

Senn-Miller
BI-5-924-16
Hooklet
16cm,

Retractors



Cushing
BI-5-925-20
Retractor
20.5cm,



Cushing
BI-5-926-08
SaddleHook
20.5cm 8mm wide, 20.5cm 10mm
wide, 20.5cm 12mm wide, 20.5cm 14mm
wide, 20.5cm 16mm wide, 20.5cm 18mm
wide,

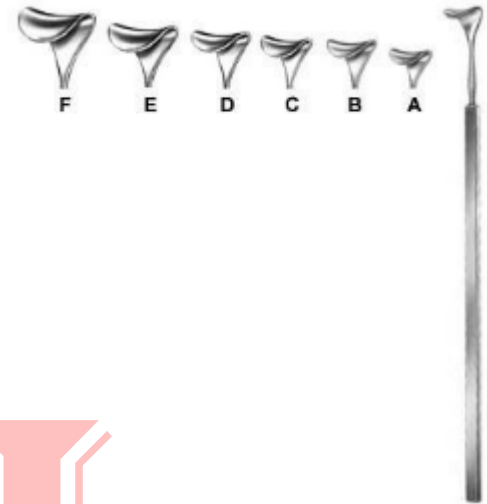

Cushing
BI-5-927-08
SaddleHook 8mm to 18mm wide
24cm,



Brom
BI-5-928-01
VeinHook
19.5cm,



Strandell-Stille
BI-5-929-01
Hooklet
19cm Fig.1, 19cm Fig.2,



Klapp
BI-5-930-01
Retractor 12x6, 12x11, 15x11
17.5cm,

Retractors



BI-5-931-04
Hooklet
16.5cm,

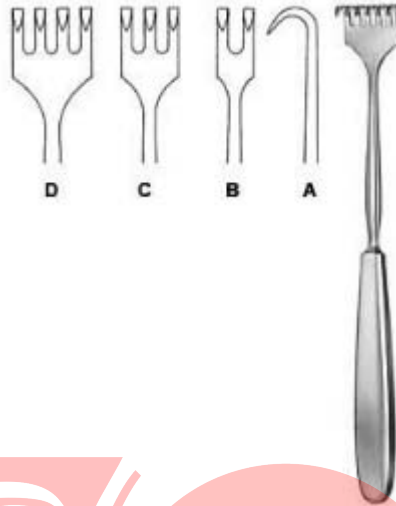

Volkman
BI-5-932-01
Retractor
21.5cm,



Volkman
BI-5-933-01
Retractor
22cm, 21.5cm,



Kocher
BI-5-934-01
Retractor
22cm,

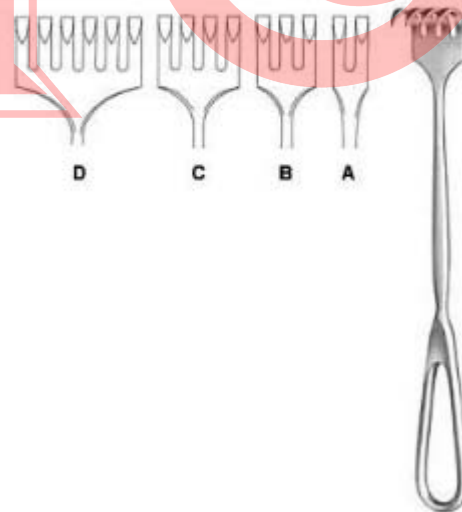

Martin
BI-5-935-02
Retractor
22.5cm,

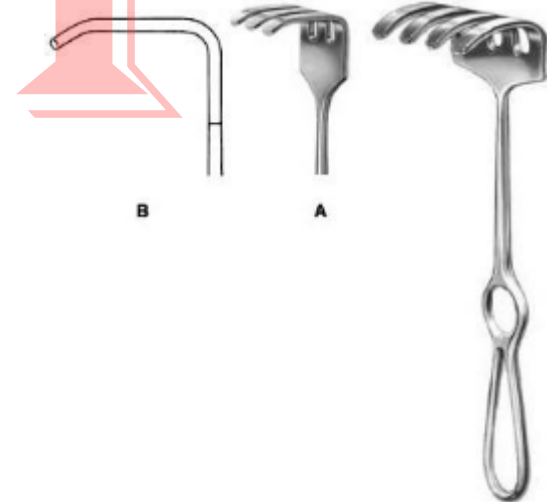

Ollier
BI-5-936-03
Retractor
23cm36x30, 23cm36x60,

Retractors



Wassmund
BI-5-937-02
 Retractor
 20.5cm33x21,

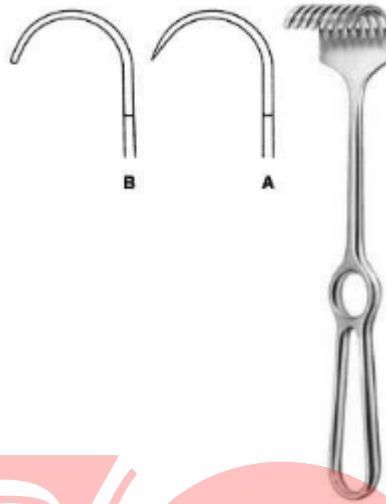

Korte
BI-5-938-08
 Retractor
 24.5cm40x30,



Israel
BI-5-939-04
 Retractor
 25.5cm,

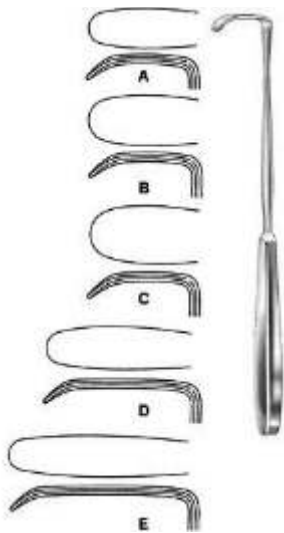

Langenbeck
BI-5-940-01
 Retractor
 22.5cm30x11mm,22.5cm30x14
 mm,22.5cm30x16mm,22.5cm40x11
 mm,22.5cm50x11mm,

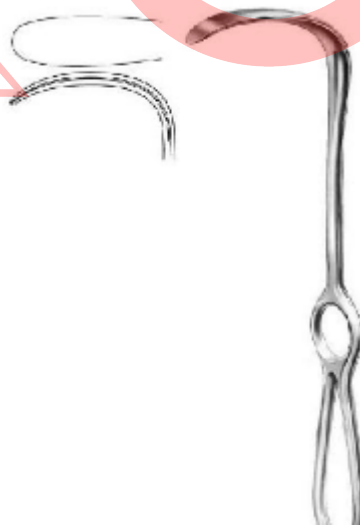

Langenbeck
BI-5-942-21
 Retractor
 21cm65x20mm,

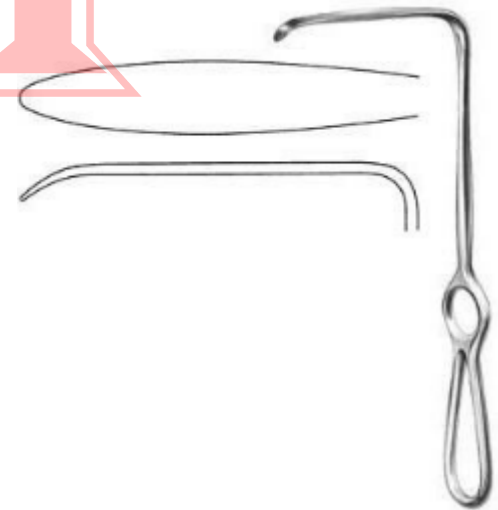

Langenbeck
BI-5-943-21
 Retractor
 22.5cm85x15mm,

Retractors



Lahey
BI-5-944-19
Retractor
19.5cm36x19mm,



Little
BI-5-945-20
Retractor
20cm13x15mm,



Kocher
BI-5-946-18
Retractor
23cm43x18mm,23cm53x20mm,23cm63x25mm,23cm77x30mm,23cm78x40mm,

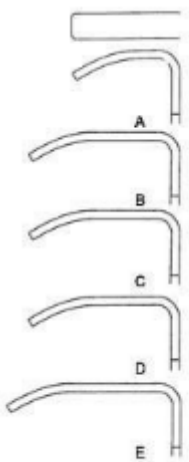

Kocher-Langenbeck
BI-5-947-01
Retractor
21.5cm25x6mm,21.5cm35x8mm,21.5cm35x11mm,21.5cm35x15mm,21.5cm40x11mm,21.5cm55x11mm,21.5cm70x14mm,21.5cm80x12mm,



Kocher-Langenbeck
BI-5-948-01
Retractor
21.5cm25x10mm,21.5cm40x13mm,21.5cm60x13mm,21.5cm40x18mm,21.5cm60x18mm,21.5cm85x18mm,21.5cm60x25mm,21.5cm85x25mm,

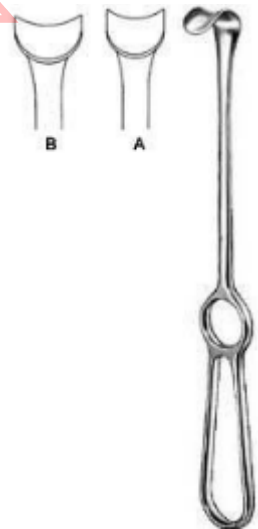

Kocher
BI-5-949-01
Retractor
21.5cm22x12mm,21.5cm24x14mm,

Retractors

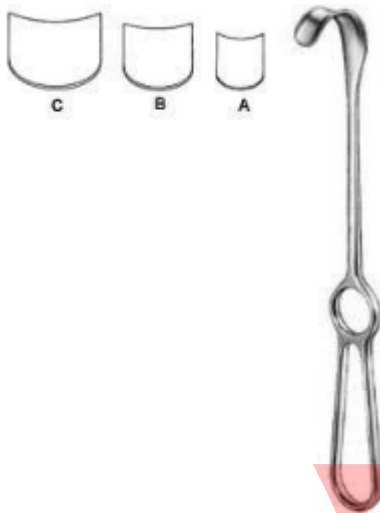

Kocher
BI-5-950-01

Retractor

22cm42x10mm, 22cm42x15mm, 22cm43x20mm,

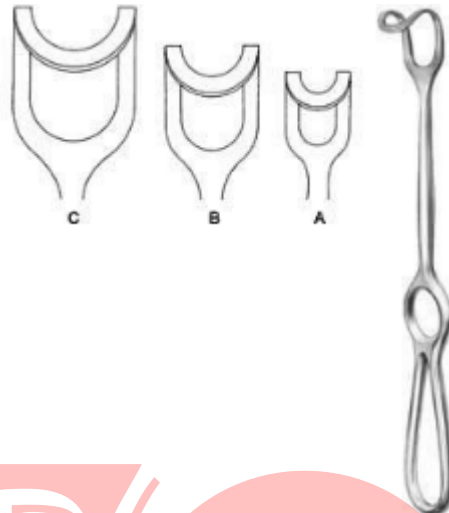

Middeldorpf

BI-5-951-01

Retractor

21.5cm18x17mm, 23cm25x22mm, 24.5cm30x31mm,



Doyen-Stillé

BI-5-952-01

Retractor

26cm97x29mm, 26cm101x31mm, 26cm127x52mm,



Hosel

BI-5-953-01

Retractor

26cm63x21mm, 26cm83x30mm, 26cm103x30mm, 26cm120x30mm, 26cm140x30mm, 26cm140x40mm,



Middeldorpf

BI-5-954-01

Retractor

27cm48x45mm, 27cm52x50mm, 27cm60x70mm,

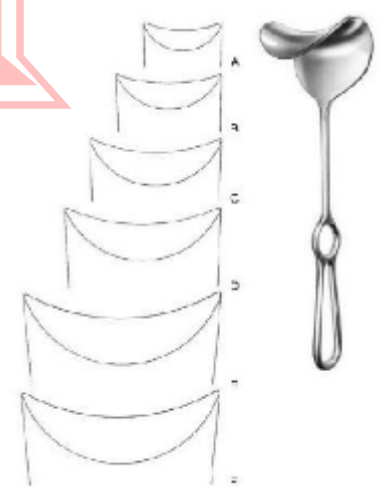

Fritsch

BI-5-955-00

Retractor

23.5cm37x31mm, 24cm38x40mm, 25cm43x51mm, 25cm49x61mm, 25.5cm48x75mm, 25.5cm65x85mm,

Retractors



Doyen
BI-5-956-25
 Retractor
 24cm48x88mm,



Kocher
BI-5-957-22
 Retractor
 24cm73x25mm,



Kocher
BI-5-958-01
 Retractor
 25cm80x45mm, 25cm80x55mm, 25
 cm80x65mm,



Martin
BI-5-959-25
 Retractor
 26cm110x27mm,

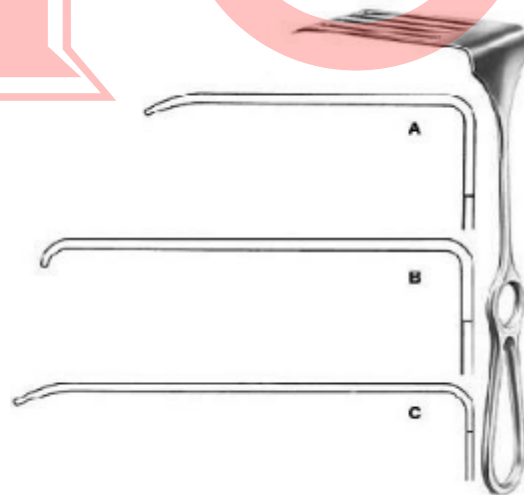

Coryllos
BI-5-960-01
 Retractor
 24cm85x22mm, 24cm108x43mm, 24
 cm119x65mm,



Davidson
BI-5-961-01
 Retractor
 19cm80x54mm, 18.5cm80x95mm,

Retractors

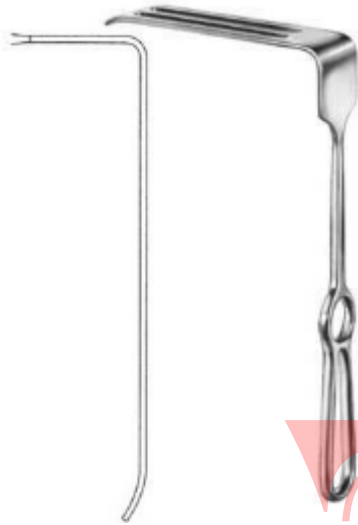

**Sauerbruch
BI-5-962-25**
Retractor
25.5cm127x38mm,

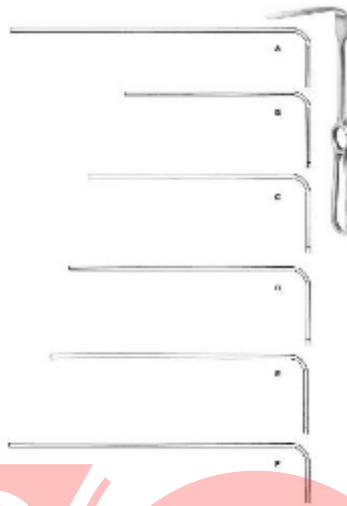

**Brunner
BI-5-963-08**
Retractor
25.5cm84x20mm,25.5cm104x25
mm,25.5cm124x30mm,25.5cm130x30
mm,25.5cm144x30mm,25.5cm160x30
mm,25.5cm164x30mm,

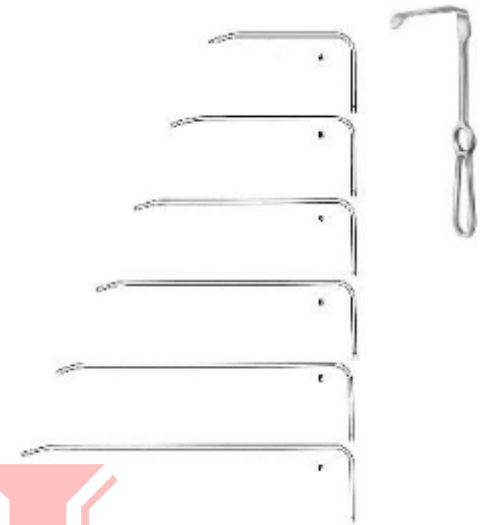

**Brunner
BI-5-964-08**
Retractor
25.5cm82x20mm,25.5cm102x20
mm,25.5cm122x25mm,25.5cm140x25
mm,25.5cm162x30mm,25.5cm182x30
mm,

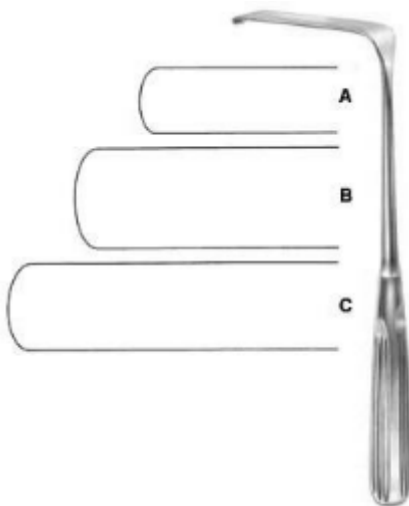

**Sauerbruch
BI-5-965-01**
Retractor
22.5cm50x15mm,22.5cm63x
23mm,22.5cm80x20mm,



**Deaver
BI-5-966-01**
Retractor
18cm19mm,

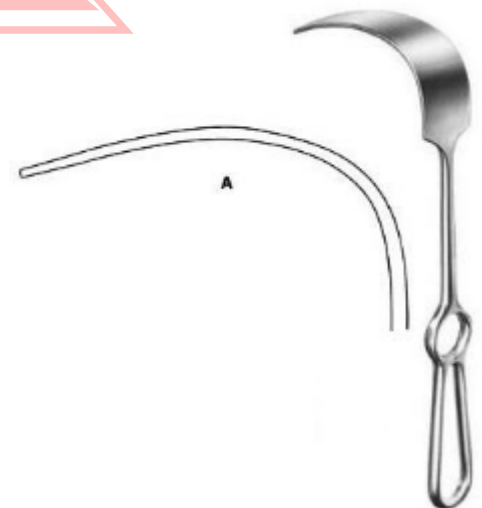

**Mikulicz
BI-5-968-01**
Retractor
25cm90x35mm,25cm125x50mm,25
cm160x50mm,

Retractors



Mikulicz
BI-5-969-26
Retractor
26cm90x55mm,

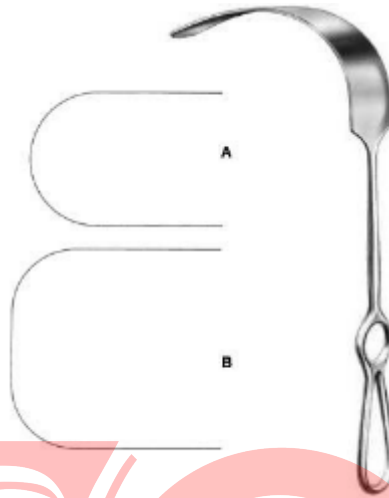

Kelly
BI-5-970-01
Retractor
27.5cm205x38mm,27.5cm205x57mm,



Farabeuf
BI-5-971-00
Retractor
15cmFig.1=23x16,15cmFig.1=26x16,15cmFig.2=27x16,15cmFig.2=30x16,

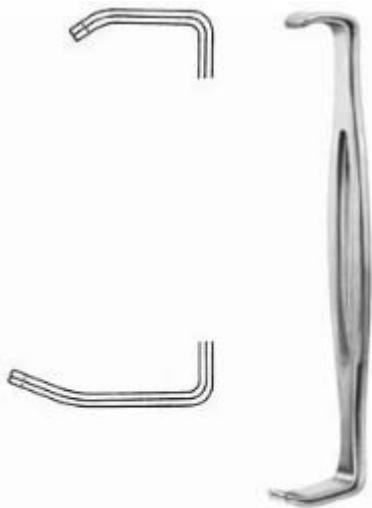

Parker-Langenbeck
BI-5-972-00
Retractor
21.5cmFig.1=21x15mm,21.5cmFig.1=40x15mm,21.5cmFig.2=25x15mm,21.5cmFig.2=45x15mm,



Alm
BI-5-973-07
WoundSpreaders,self-retaining
7cm,



Alm
BI-5-974-07
WoundSpreaders,self-retaining
7cm,

Retractors



Gosset
BI-5-975-22
 Abdominal Retractor
 18.5cm,



Balfour-Baby
BI-5-976-00
 Abdominal Retractors preading 90mm, 1
 central blade 24x20mm
 12.5cm,



Balfour
BI-5-977-00
 Abdominal Retractors preading 180mm,
 lateral blades 70x35mm, 1 central blade
 20cm,



Deaver
BI-5-967-04
 Retractor
 31.5cm 25mm, 31.5cm 38mm, 31.5cm
 50mm, 31.5cm 100mm,

Probes



BI-5-1001-11
Probe

11.5cm, 13cm, 14.5cm, 16cm, 18cm, 20cm, 25cm, 30cm,



BI-5-1002-11
Probe

11.5cm, 13cm, 14.5cm, 16cm, 18cm, 20cm, 25cm, 30cm,

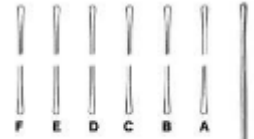

BI-5-1003-13
Probe

13cm, 14.5cm, 16cm, 18cm, 20cm, 25cm,



BI-5-1004-13

Probewitheye
13cm, 14.5cm, 16cm,

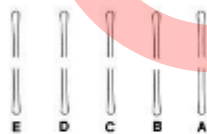

BI-5-1006-13

MyrtleLeafProbe
13cm, 14.5cm, 16cm, 18cm, 20cm,



BI-5-1007-13

GroovedDirector
13cm, 14cm, 16cm,

Probes



BI-5-1008-13
Grooved Director
13cm, 14.5cm, 16cm,



Doyen
BI-5-1009-14
Grooved Director
14.5cm,



Nelaton
BI-5-1010-16
Grooved Director
16cm,

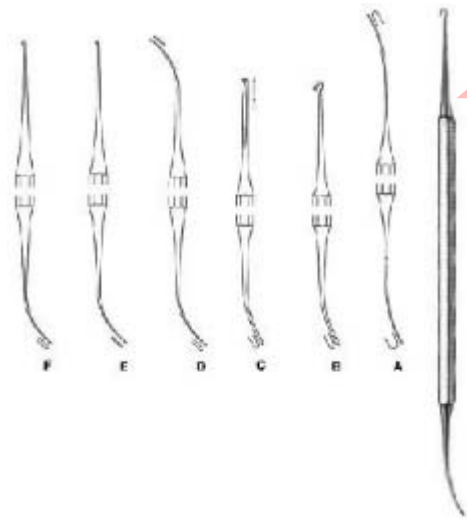

Varady
BI-5-1011-01
Phlebodissector
18cm, 17.5cm,

Plaster

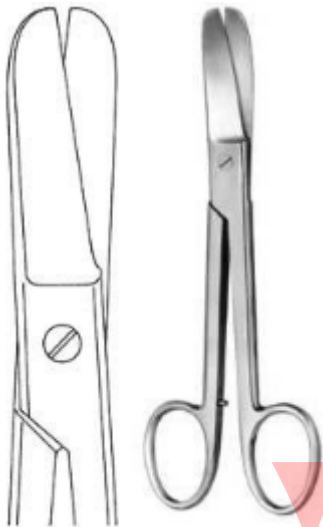

Lorenz
BI-6-101-23
 Bandage Scissors sheav pattern
 23cm,



Lister
BI-6-102-14
 Bandage Scissors
 14.5cm, 18.5cm, 20cm,



Bergmann
BI-6-103-23
 Plaster Shears
 23.5cm,



Esmarch
BI-6-104-20
 Plaster Shears sheav pattern, short blades
 20cm,



BI-6-105-15
 Bandage Scissors black plastic ring with
 autodavable
 16cm, 19cm,



BI-6-106-18
 Bandage Scissors black plastic rings
 19cm, 16cm,

Plaster



Brun's
BI-6-107-24
 Plaster Scissors
 24cm,

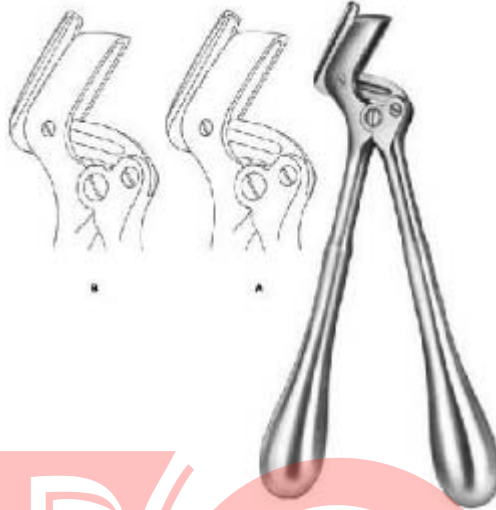

Stille-Martin
BI-6-108-23
 Plaster Shears
 23cm, 27cm, 38cm,

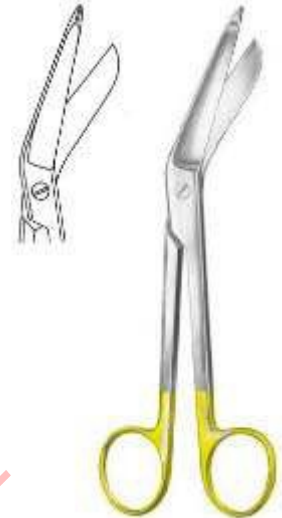

Lister
BI-6-109-18
 Bandage Scissors
 18cm,

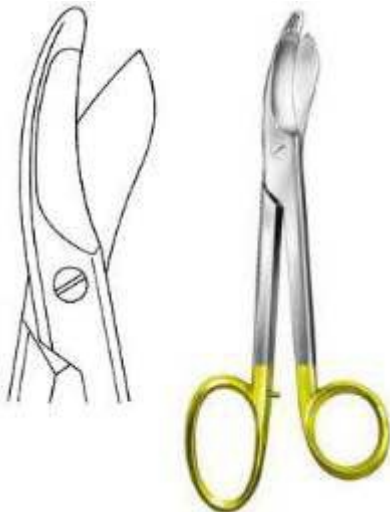

Brun's
BI-6-110-24
 Plaster Scissors
 24cm,



Hopkins
BI-6-111-20
 Plaster Knife with wooden handle
 20cm,



Reiner
BI-6-112-18
 Plaster Knife
 18cm,

Plaster



Reiner
BI-6-113-18
PlasterKnife
18cm,



Martin
BI-6-114-21
PlasterKnifewithwoodenhandle
21cm,



Engel
BI-6-115-14
PlasterSaw
15.5cm,

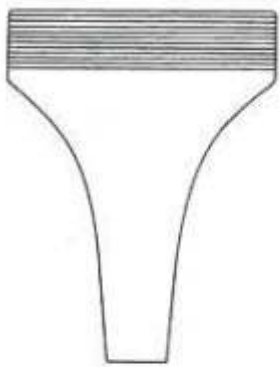

Hennig
BI-6-116-28
PlasterSpreader
28cm,

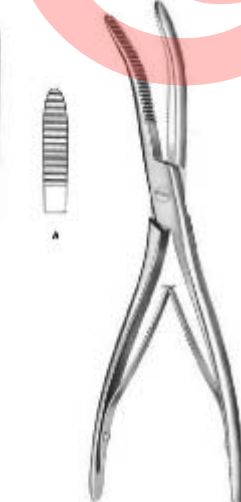

Wolff
BI-6-117-18
PlasterBreaker
18cm,26.5cm,

Neurosurgery



Gigli
BI-8-101-01
WireSawHandle



DeMartel
BI-8-102-33
WireSawGuide
33cm,



Crutchfield
BI-8-103-01
SkullTractionTongsmallpattern



BI-8-104-01
SkullTractionTonglargepattern
22.5cm,



Dahlgren
BI-8-105-20
CranialRongeur
20cm,



Olivecrona-Toennis
BI-8-106-14
ClipApplyingForceps

Neurosurgery



McKenzie
BI-8-107-19
ClipApplyingForceps
18.5cm,



Olivecrona
BI-8-108-18
DuraDissector
18cm,



Olivecrona
BI-8-109-19
DuraDissector
20cm,



Milligan
BI-8-110-21
DuraDissector
21.5cm,



Davis
BI-8-111-21
DuraDissectorsharp
21.5cm,



BI-8-112-22
DuraDissector
22cm,

Neurosurgery



Davis
BI-8-113-24
 DuraDissector
 24.5cm,



Love
BI-8-114-19
 NerveRootRetractor
 21.5cm, 18cm, 11cm,



Olivecrona
BI-8-115-18
 BrainSpatula
 18cm,



Scoville
BI-8-116-23
 NerveRootRetractor8mm
 23.5cm,



Holsher
BI-8-117-24
 NerveRootRetractor8mm
 23.5cm,

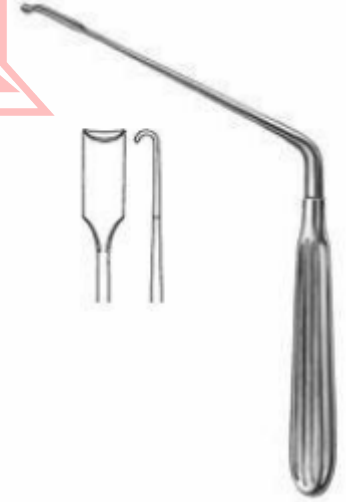

Scoville
BI-8-118-19
 NerveRootRetractor7mm
 16.5cm,

Neurosurgery



Groningen
BI-8-119-26
NerveHook
26.5cm,



Groningen
BI-8-120-26
NerveHook
26.5cm,



Cushing
BI-8-121-19
NerveHookblunt
19cm,28cm,

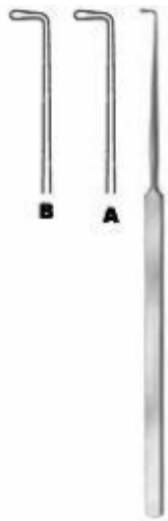

Cushing
BI-8-122-19
NerveHook
19.5cm,28cm,



Smithwick
BI-8-123-17
NerveHook
17cm,21cm,



Halle
BI-8-125-20
DuraKnife
20cm,

Neurosurgery



Adson
BI-8-126-20
 DuraHook
 20cm,



Graham
BI-8-127-16
 DuraHookblunt
 16.5cm,



Sachs
BI-8-128-18
 DuraHooksharp
 18cm,



Toennis
BI-8-129-15
 DuraHooksharp
 14.5cm,



Frazier
BI-8-130-13
 DuraHooksharp
 13cm, 18cm,



Krayenbuhl
BI-8-131-01
 Nerve and Vessel Hooklet
 18.5cm Fig.1, 18.5cm Fig.2,

Neurosurgery



Cloward
BI-8-132-16
 Lamina Spreader
 16cm,

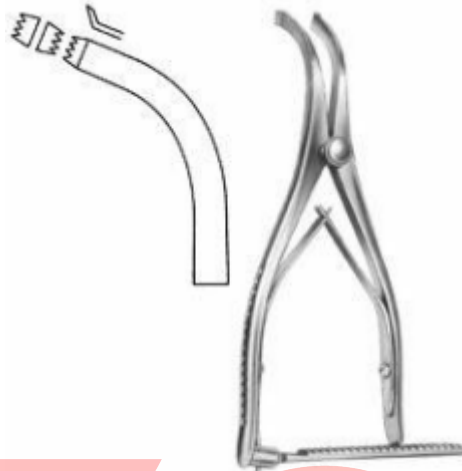

Inge
BI-8-133-17
 Lamina Spreader
 16cm,

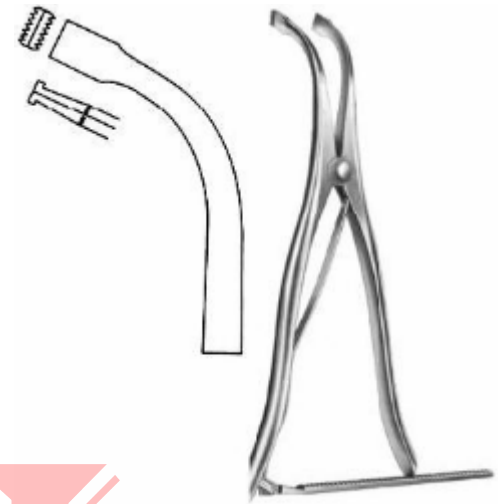

Inge
BI-8-134-27
 Lamina Spreader
 25.5cm,



Ferris-Smith Kerrison
BI-8-135-03
 Laminectomy Punch 3mm downwards
 cutting 40 degree shaft length 180mm

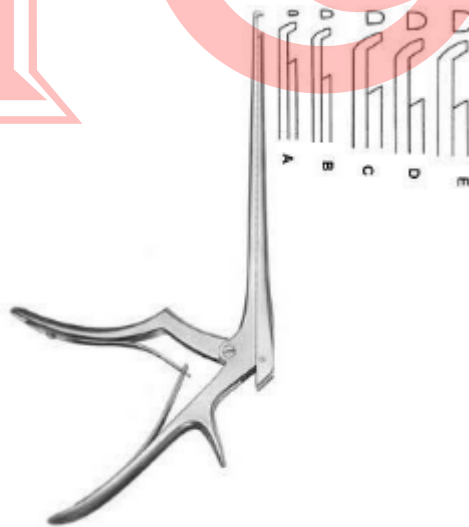

Ferris-Smith Kerrison
BI-8-138-01
 Laminectomy Punch upwards cutting shaft
 length 180mm
 1mm, 2mm, 3mm, 4mm, 5mm, 6mm,

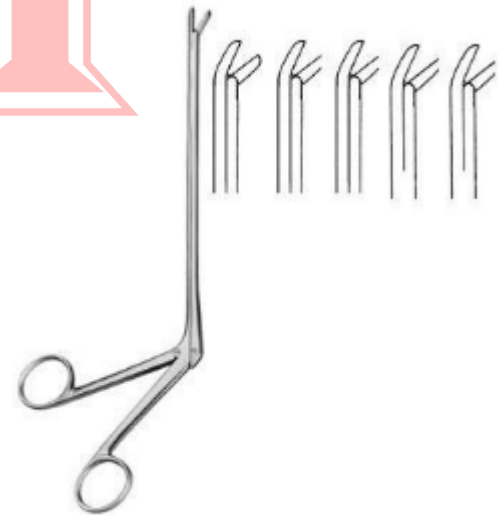

Cushing
BI-8-139-01
 Laminectomy Rongeur jaw 2x10 to 4x10
 mm straight shaft length 180mm

Neurosurgery

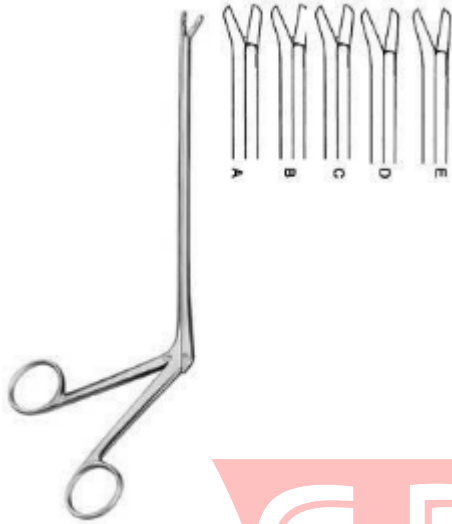

Cushing
BI-8-140-01

Laminectomy Rongeur jaw 2x10 to 4x10 mm upwards 45 degree shaft length 120 mm



Ferris-Smith Kerrison
BI-8-137-01

Laminectomy Punch
1mm, 2mm, 3mm, 4mm, 5mm, 6mm,

Cardiovascular



BI-9-101-23
BoneShear
23cm,



BI-9-102-22
RibShear
23cm,



Gluck
BI-9-103-22
RibShears
21cm,



Giertz-Stille
BI-9-104-27
RibShear
24.5cm,



Lebsche
BI-9-105-24
SternumChisel
24.5cm,

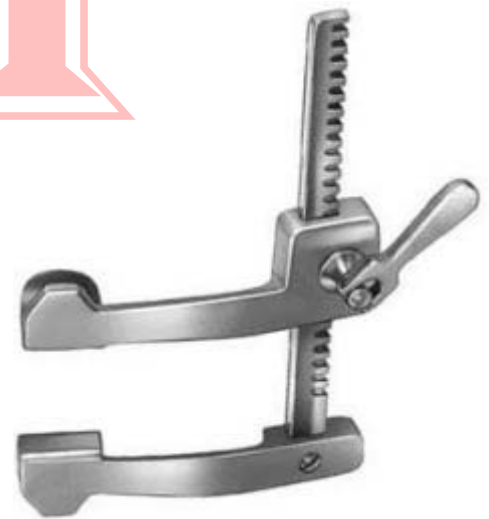

BI-9-106-01
RibRetractorlateralblades12x16mm
spreading95mm
Size1,

Cardiovascular



Finochietto, Infant
BI-9-107-01

Rib Retractor lateral blades 15x15mm
spreading 75mm
Size 1,



Finochietto, Baby
BI-9-108-01

Rib Retractor lateral blades 31x31mm
spreading 100mm
Size 1,



Finochietto
BI-9-109-01

Rib Retractor lateral blades 40x45mm
spreading 135mm
Size 1,



Burford
BI-9-110-01

Rib Retractor with two pairs of blades 47x
62mm+65x62mm, spreading 200mm
Size 1,

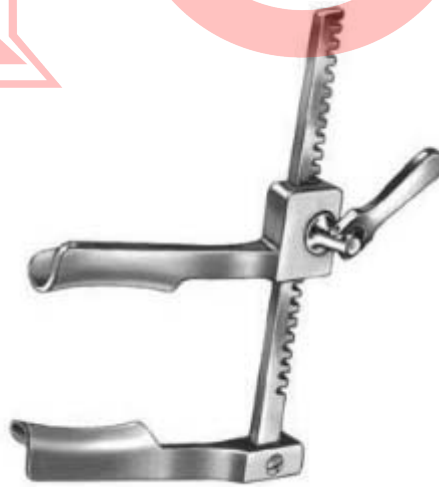

Castaneda
BI-9-111-01

Rib Retractor lateral blades 10,5x32mm
spreading 65mm
Size 1,

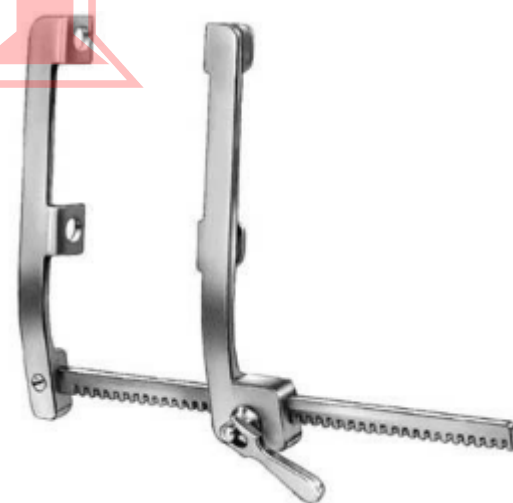

Finochietto(modif.)
BI-9-112-01

Rib Retractor lateral blades 14x15mm
spreading 120mm
Size 1,

Cardiovascular



Haight
BI-9-113-90

Rib Retractor lateral blades 30x30mm
spreading 120mm
Size 1,



Morse-Favaloro
BI-9-114-01

Sternal Retractor 4 movable blades 17x22
mms spreading 160mm Sternal Retractor
Size 1,



Morse
BI-9-115-00

Sternal Retractor 4 movable blades 22x27
mms spreading 200mm
Size 1,



Tuffier
BI-9-116-02

Rib Retractor lateral blades 22x27mm
spreading 200mm
Size 1,

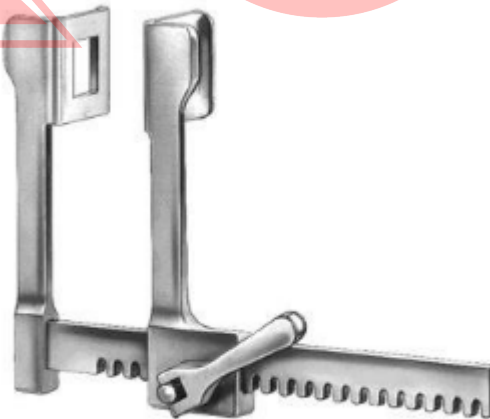

Finochietto, Baby
BI-9-117-75

Rib Retractor lateral blades 14x15mm
spreading 75mm
Size 1,



Finochietto
BI-9-118-01

Rib Retractor lateral blades 30x45mm
spreading 150mm
Size 1,

Cardiovascular



DeBakey
BI-9-119-00
Rib Retractors spreading 150mm
Size 1,



DeBakey
BI-9-120-00
Rib Retractors spreading 200mm
Size 1,



BI-9-121-00
Thoracic Retractor
Size 1,



Sellers
BI-9-122-19
Rib Contractor
20cm,



Bailey-Baby
BI-9-123-14
Rib Contractor
15.5cm,



Bailey
BI-9-124-16
Rib Contractor
20cm,

Cardiovascular



Bailey-Gibbon
BI-9-125-16
 RibContractor
 20cm,



Allison
BI-9-126-30
 LungSpatula
 29.5cm,32.5cm,



Price-Thomas
BI-9-127-22
 BronchusClamp
 22cm,



Price-Thomas
BI-9-128-22
 BronchusClamp
 22cm,

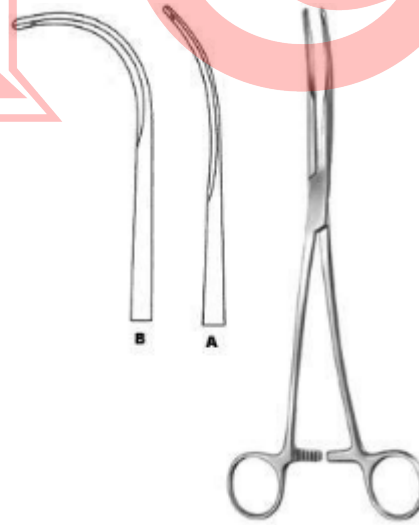

Semb
BI-9-129-24
 BronchusClamp
 24.5cm,



Lovlace
BI-9-130-20
 LungGraspingForceps
 20.5cm,

Cardiovascular



Lovelace
BI-9-131-20
 Lung Grasping Forceps
 19cm,



DeBakey-Satinsky
BI-9-132-07
 Bulldog Clamp
 7cm, 9cm,



Glover
BI-9-133-06
 Bulldog Clamp
 6cm,



Santulli
BI-9-134-07
 Bulldog Clamp
 7cm,



Gregory, soft
BI-9-135-09
 Bulldog Clamp
 9cm, 11cm,



Gregory
BI-9-136-01
 Bulldog Clamp
 10.5cm,

Cardiovascular

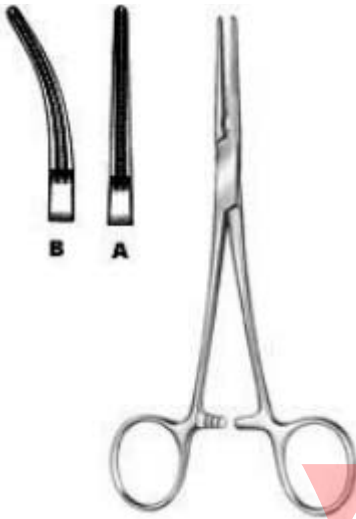

DeBakey-Rankin
BI-9-137-16
 Haemostatic Forceps
 16cm,



DeBakey-Mosquito
BI-9-138-15
 Haemostatic Forceps
 15cm,



Ochsner
BI-9-139-23
 Aortic Clamp
 23.5cm,



Diethrich
BI-9-140-21
 Aortic Clamp
 22cm,

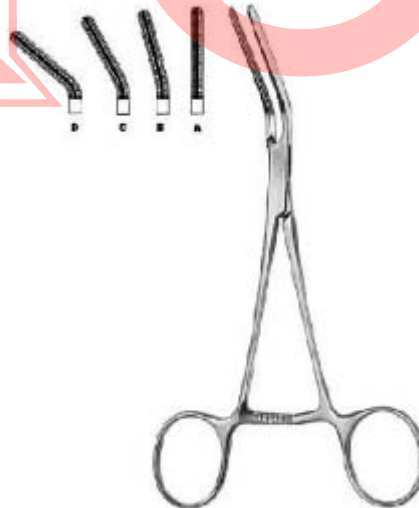

Dardik
BI-9-141-00
 Multipurpose Vascular Clamp
 15cm,



Dale
BI-9-142-18
 Peripheral Vascular Clamp
 18cm,

Cardiovascular

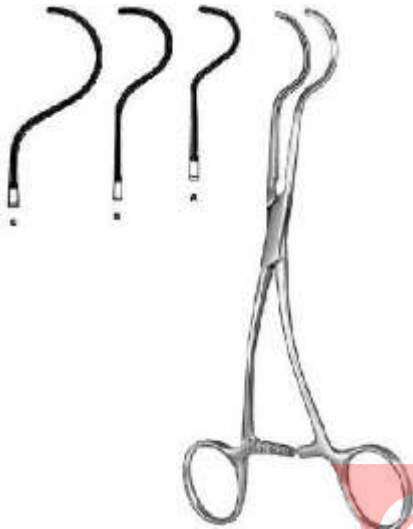

Dale
BI-9-143-17
 Peripheral Vascular Clamp
 17.5cm,

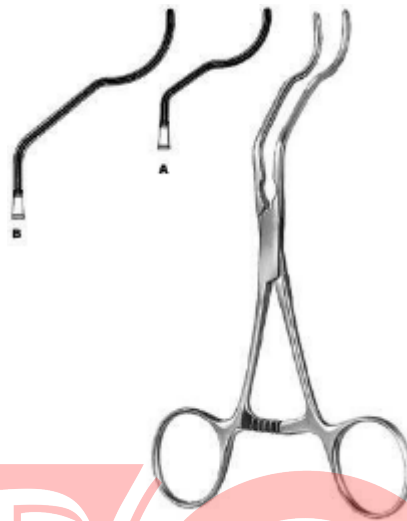

Gregory
BI-9-144-14
 Profunda Clamp
 13cm, 16cm, 18cm,

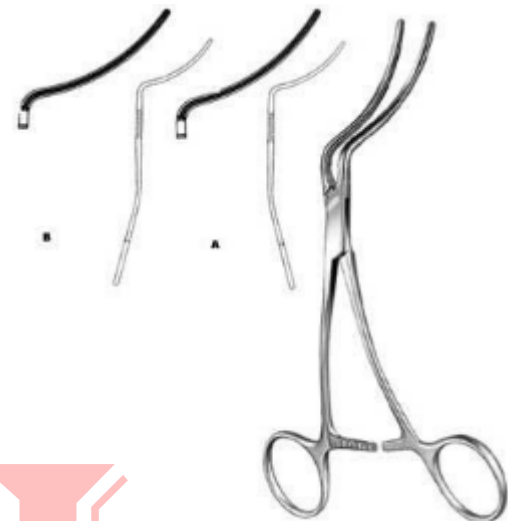

Martin
BI-9-145-16
 Peripheral Vascular Clamp
 16.5cm,



Husfeldt
BI-9-146-18
 Peripheral Vascular Clamp
 17.5cm,



Husfeldt
BI-9-147-18
 Peripheral Vascular Clamp
 18cm,



Husfeldt
BI-9-148-17
 Peripheral Vascular Clamp
 17cm,

Cardiovascular



DeBakey
BI-9-149-16
Vascular Forceps
16cm,



DeBakey
BI-9-150-16
Vascular Forceps
16cm,



DeBakey
BI-9-151-16
Vascular Forceps
16cm,



DeBakey
BI-9-152-16
Vascular Forceps
16cm,



DeBakey
BI-9-153-16
Vascular Forceps
16cm,



DeBakey
BI-9-154-07
Bulldog Clamp
7.5cm,

Cardiovascular



DeBakey
BI-9-155-07
 BulldogClamp
 7.5cm,



BI-9-156-23
 ApplyingForceps
 23.5cm,



Glover
BI-9-157-06
 BulldogClamp
 7cm,



Glover
BI-9-158-06
 BulldogClamp
 6.5cm,



Potts
BI-9-159-21
 CoarctationClamp
 21cm,

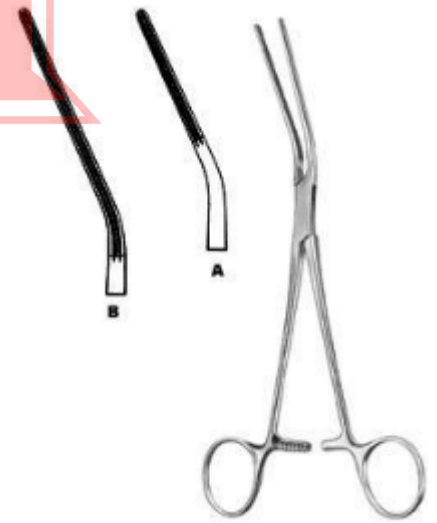

Potts
BI-9-160-21
 CoarctationClamp
 20.5cm,

Cardiovascular

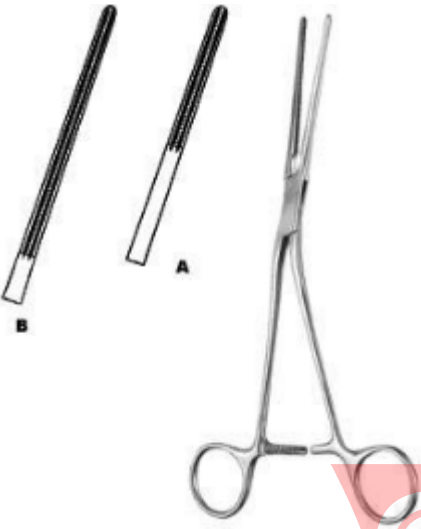

Potts
BI-9-161-21
CoarctationClamp
20.5cm,



Potts
BI-9-162-22
AnastomosisClamp
21.5cm,



Potts
BI-9-163-22
AnastomosisClamp
22cm,



DeBakey
BI-9-164-19
LigatureForceps
19cm,



DeBakey
BI-9-165-16
Peripheral/VascularClamp
16cm,

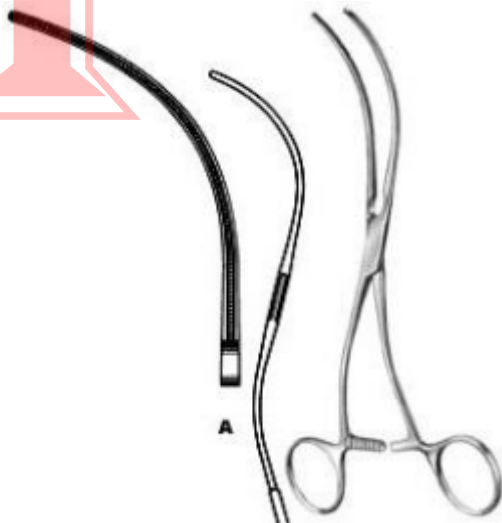

DeBakey
BI-9-166-19
Peripheral/VascularClamp
16cm,

Cardiovascular

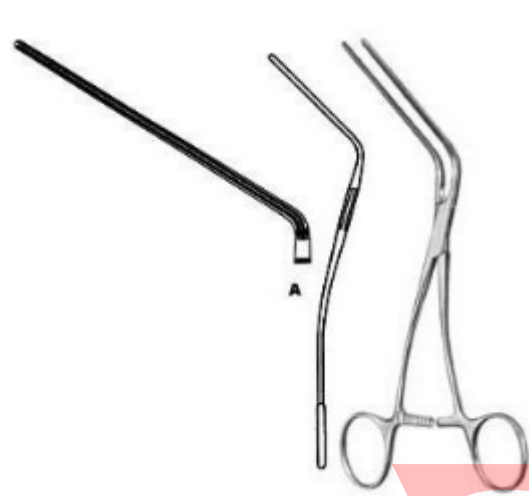

Leland-Jones
BI-9-167-18
 Peripheral Vascular Clamp
 18cm,

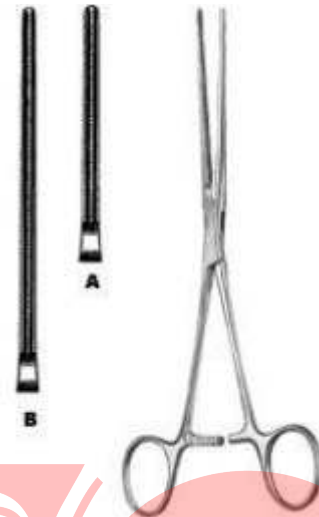

Bainbridge
BI-9-168-15
 Multipurpose Vascular Clamp
 15cm,



Bainbridge
BI-9-169-15
 Multipurpose Vascular Clamp
 15cm,

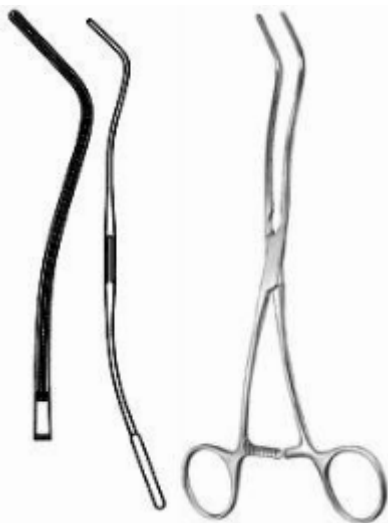

DeBakey
BI-9-170-20
 Multipurpose Vascular Clamp
 20cm,

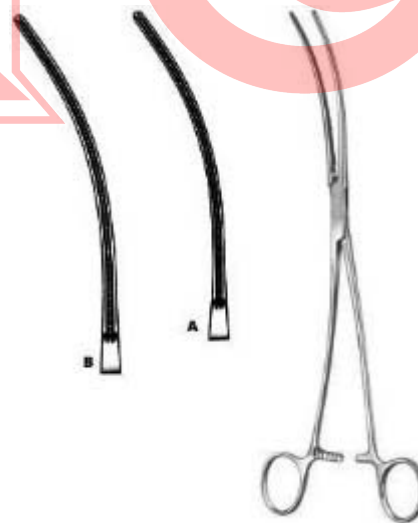

DeBakey
BI-9-171-26
 Aortic Aneurysm Clamp
 26cm,

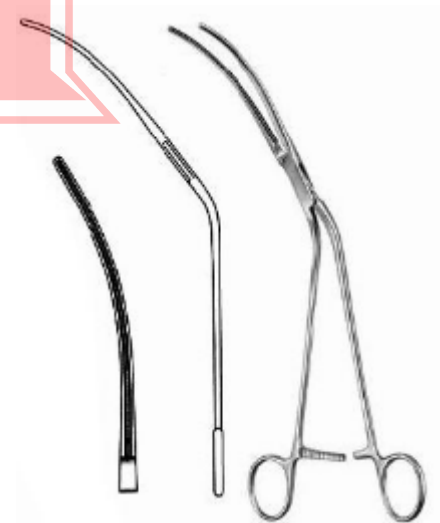

DeBakey
BI-9-172-28
 Aortic Aneurysm Clamp
 28cm,

Cardiovascular

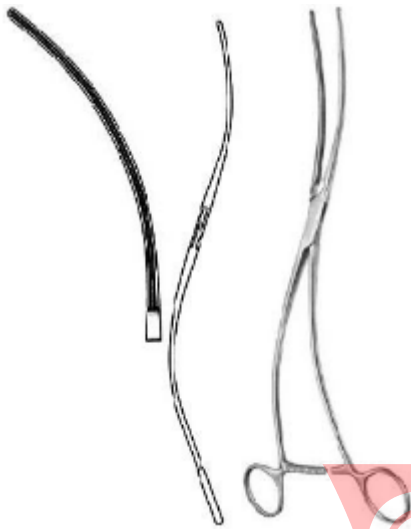

DeBakey
BI-9-173-30
 Aortic Aneurysm Clamp
 30cm,

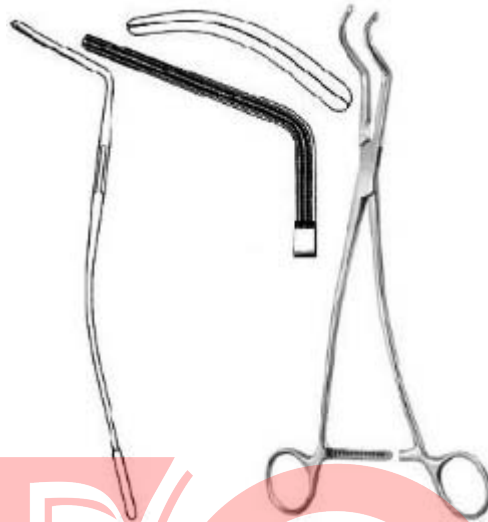

DeBakey
BI-9-174-27
 Aortic Clamp
 27cm,



DeBakey
BI-9-175-24
 Ligature Forceps
 24.5cm,



DeBakey
BI-9-176-24
 Ligature Forceps
 24.5cm,

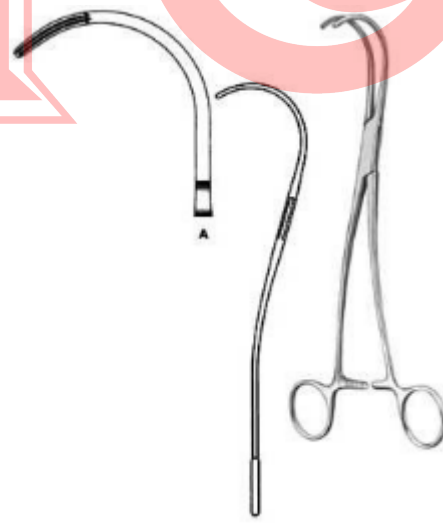

DeBakey
BI-9-178-25
 Ligature Forceps
 27cm,

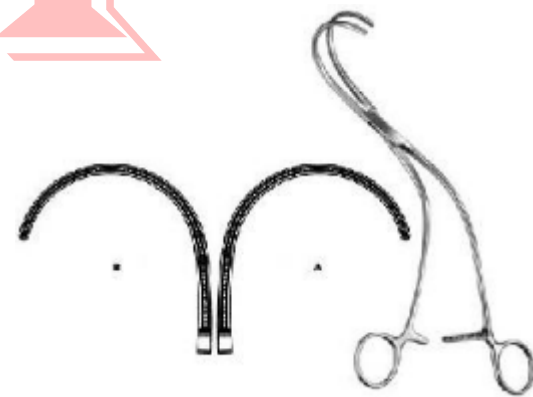

Weber
BI-9-179-01
 Aortic Clamp
 24cm,

Cardiovascular

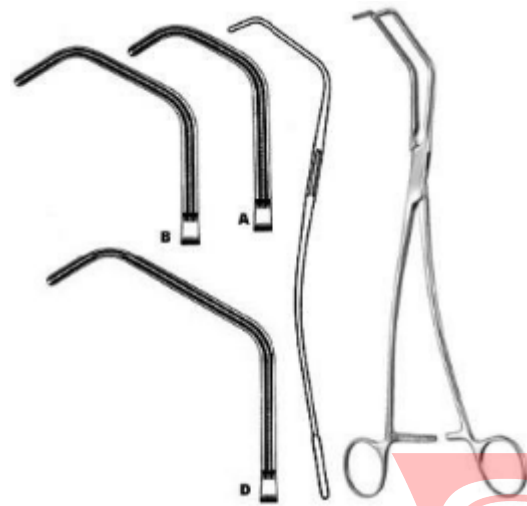

Satinsky
BI-9-180-20
 Tangential Occlusion Clamp
 22cm,



Harken
BI-9-181-01
 Auricle Clamp
 24.5cm,



Lees
BI-9-182-23
 Bronchus Clamp
 23cm,



Lees
BI-9-183-25
 Bronchus Clamp
 25cm,



Lambert-Kay
BI-9-184-21
 Anastomosis Clamp
 22.5cm,

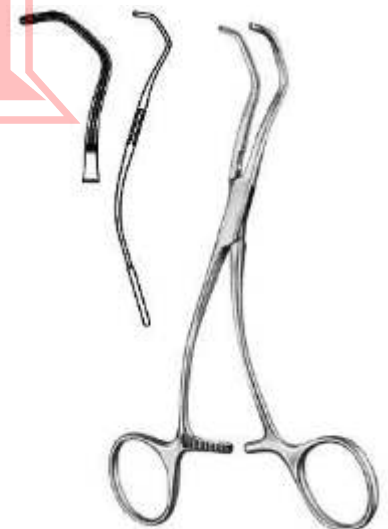

DeBakey
BI-9-185-17
 Anastomosis Clamp
 16.5cm,

Cardiovascular



Morris-DeBakey
BI-9-186-18
 AorticClamp
 16.5cm,



DeBakey-Bahnsen
BI-9-187-23
 AneurysmClamp
 23.5cm,

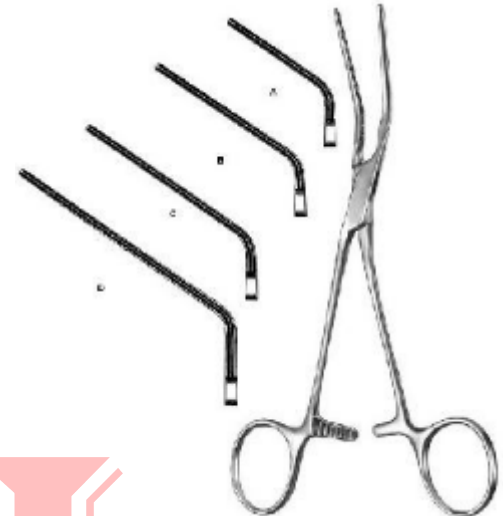

DeBakey
BI-9-188-20
 MultipurposeVascularClamp
 18cm,

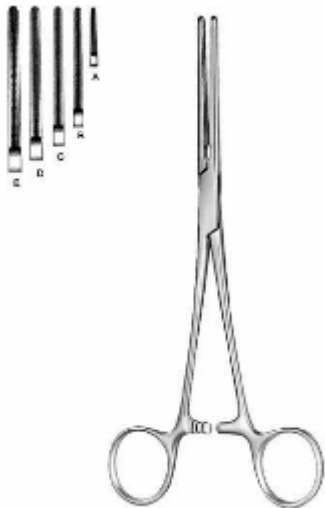

DeBakey-Mosquito
BI-9-189-12
 HaemostaticForceps
 12.5cm,

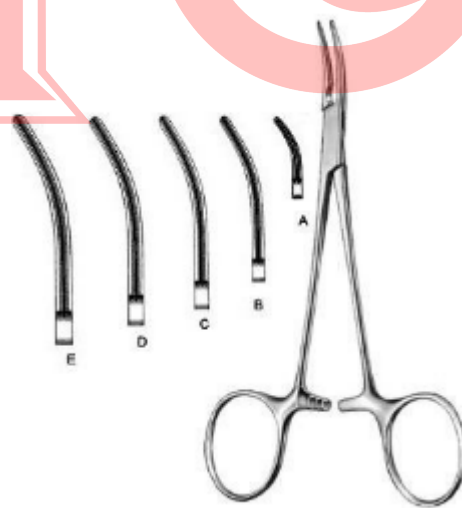

DeBakey-Mosquito
BI-9-190-12
 HaemostaticForceps
 12.5cm,



DeBakey
BI-9-191-17
 MultipurposeVascularClamp
 17cm,

Cardiovascular



DeBakey
BI-9-192-16
Multipurpose Vascular Clamp
16.5cm,

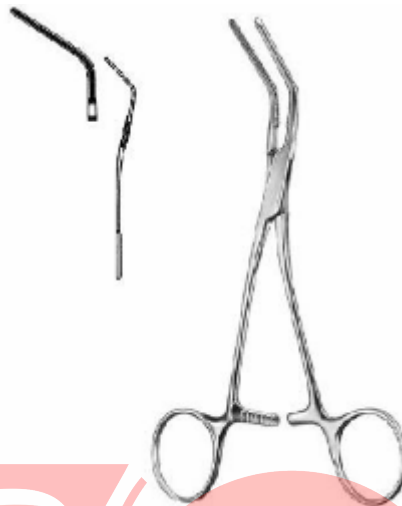

DeBakey
BI-9-193-15
Multipurpose Vascular Clamp
16cm,

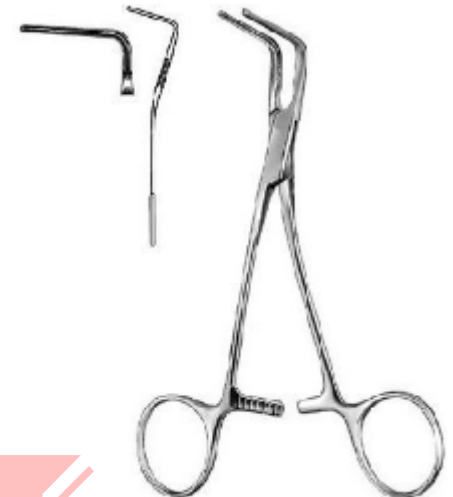

DeBakey
BI-9-194-15
Multipurpose Vascular Clamp
16.5cm,



DeBakey
BI-9-195-17
Multipurpose Vascular Clamp
16.5cm,



Glover
BI-9-196-17
Multipurpose Vascular Clamp
17cm,



Glover
BI-9-197-17
Multipurpose Vascular Clamp
17.5cm,

Cardiovascular



DeBakey
BI-9-198-16
 Multipurpose Vascular Clamp
 16.5cm,

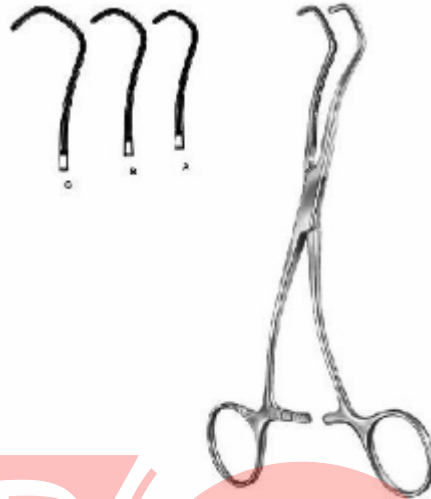

Derra
BI-9-199-16
 Anastomosis Clamp
 16.5cm Fig.1, 17cm Fig.2, 18cm Fig.3,



DeBakey-Beck
BI-9-200-17
 Anastomosis Clamp
 17cm,



Cooley
BI-9-201-16
 Vascular Forceps
 16cm,

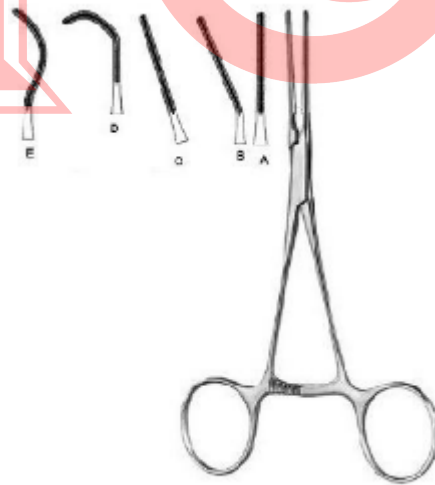

Cooley
BI-9-202-01
 Pediatric Vascular Clamp
 14.5cm,



Cooley
BI-9-203-21
 Iliac Clamp
 22cm,

Cardiovascular



Cooley
BI-9-204-17
 AnastomosisClamp
 17cm,

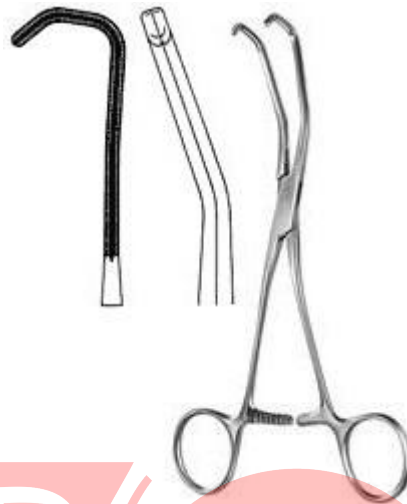

Cooley
BI-9-205-17
 AnastomosisClamp
 20cm,



Cooley
BI-9-206-16
 AnastomosisClamp
 17cm,



Cooley
BI-9-207-15
 MultipurposeVascularClamp
 16cm,



Cooley
BI-9-208-17
 MultipurposeVascularClamp
 17cm,



Cooley
BI-9-209-17
 MultipurposeVascularClamp
 17cm,

Cardiovascular



Cooley
BI-9-210-17
 Multipurpose Vascular Clamp
 17.5cm,



Cooley
BI-9-211-16
 Multipurpose Vascular Clamp
 16.5cm,



Cooley-Derra
BI-9-212-16
 Anastomosis Clamp
 16.5cm,



Cooley-Beck
BI-9-213-17
 Anastomosis Clamp
 17cm,

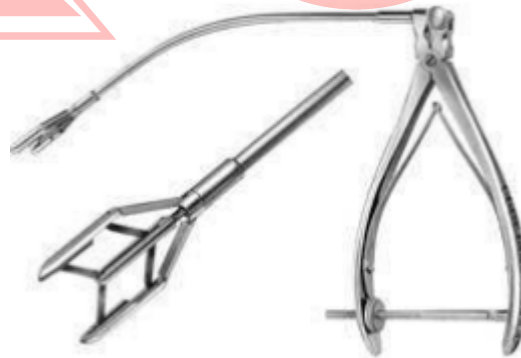

Cooley
BI-9-214-00
 Aortic Dilator

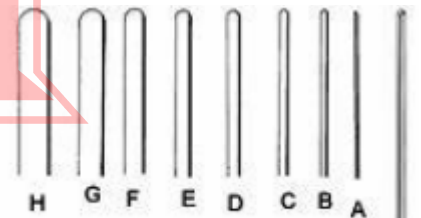

Cooley
BI-9-215-05
 Vascular Dilator
 13cm, 0.5mm?,

Cardiovascular



DeBakey
BI-9-216-05
 Vascular Dilator
 19cm, 0.5mm?



Martin
BI-9-217-00
 Tunneling Set complete set with three shafts, two handles and 12 tips in storage case.



Hach
BI-9-218-01
 Fasciotomy Knife with plastic handle
 30cm,



BI-9-219-18
 Intima Spatula
 18.5cm,

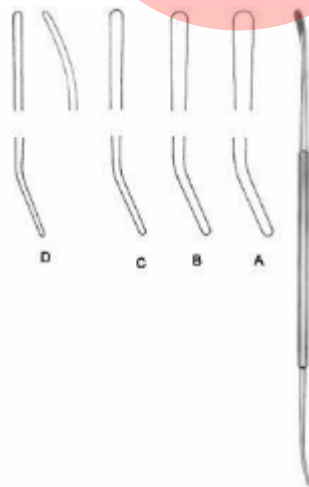

Robb
BI-9-220-01
 Vascular Dissector
 24cm Fig. 12, 5mm?, 24cm Fig. 22, 0 mm?,



Crile
BI-9-221-20
 Nerve Hooklet
 20cm,

Cardiovascular

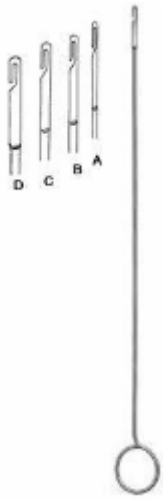

BI-9-222-15
Ligature Catcher
26cm 1,5mm,



Subramanian-Miniature
BI-9-223-15
Aortic Clamp 135 degree
15.5cm,

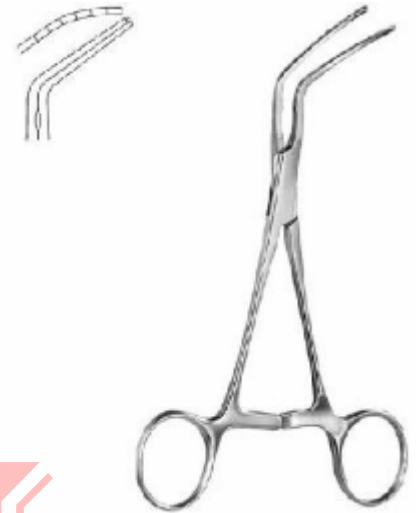

Subramanian
BI-9-224-16
Aortic Clamp
16cm,

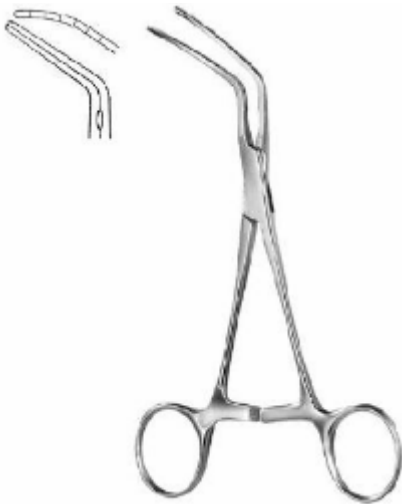

Subramanian
BI-9-225-16
Aortic Clamp
13.5cm Fig.1, 13.5cm Fig.2, 14cm Fig.3,

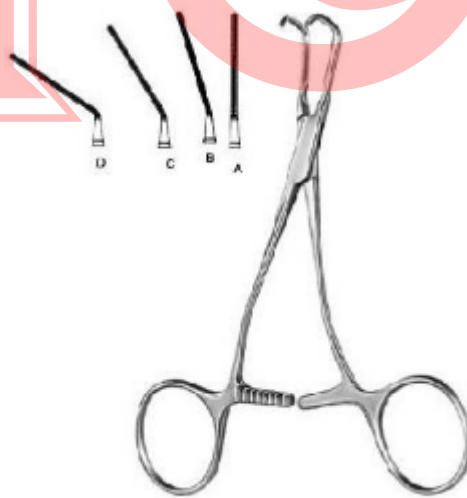

BI-9-226-01
Pediatric Vascular Clamp



BI-9-227-16
Pediatric Vascular Clamp
16.5cm,

Cardiovascular



BI-9-228-16
PediatricVascularClamp
16cm,

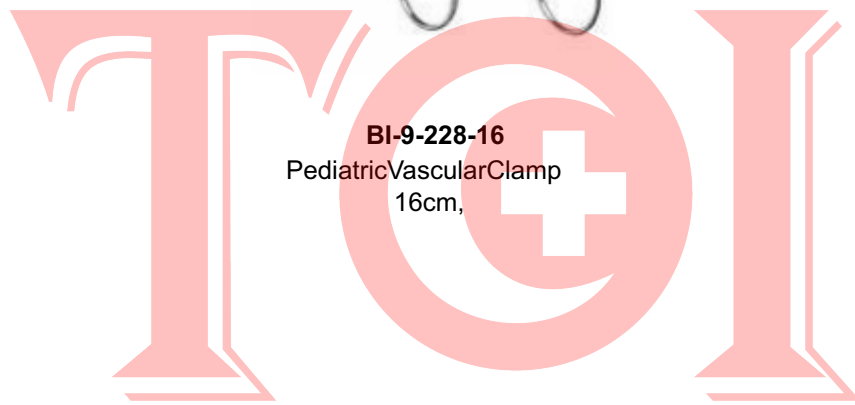

Ophthalmology



Barraquer(Colibri)
BI-11-101-03
Barraquer
Size1,



BI-11-102-07
Bowman
Size1,



BI-11-103-06
Critchett
Size1,



BI-11-104-05
Smith
Size1,

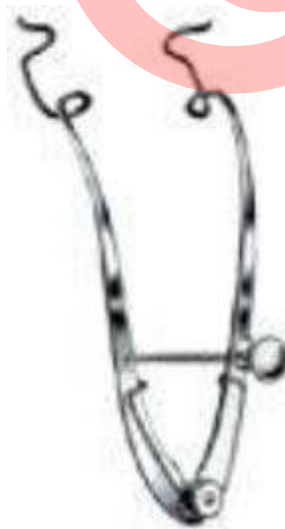

BI-11-105-08
Clark
Size1,



BI-11-106-06
Graefe
Size1,

Ophthalmology



BI-11-107-08
Week
Size1,



BI-11-108-07
Arruga
Size1,



BI-11-109-07
Arruga
Size1,



BI-11-110-05
Murdock
Size1,



Millenger
BI-11-111-07
MellingerAxenfeld
Size1,



Millenger
BI-11-112-07
MellingerAxenfeld
Size1,

Ophthalmology



Millinger
BI-11-113-07
Mellinger
Size1,



BI-11-114-08
ListerBurch
Size1,



WilliamsEyeSpeculum
BI-11-115-08
Williams
7cm,8.3cm,



Lancaster
BI-11-116-07
Lancaster
Size1,



BI-11-118-08
Ziegler
Size1,



Mueller
BI-11-120-07
Mueller
Size1,

Ophthalmology



Jaeger Lid Plate
BI-11-121-11
Jaeger
4", 20mm, 23mm,

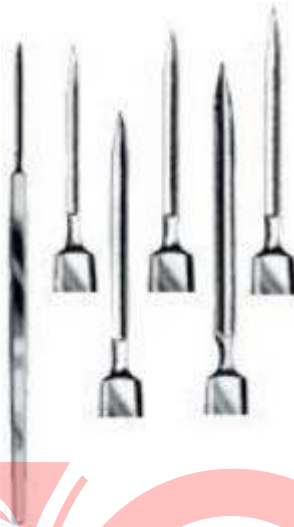

VONGRAEFEKnife
BI-11-122-03
Graefe
1, 2, 3, 4, 5,



BI-11-123-01
Jaeger
Size 1,



BI-11-124-13
Berens
Size 1,

ZIEGLERknifeNeedle
BI-11-126-01
Ziegler
11.4cm,



Castroviejo Cyclo dialysis Spatula
BI-11-127-12
Castroviejo
13.3cm,

Ophthalmology



BI-11-128-12
Wheeler
Size1,



Castroviejo Cyclodialysis Spatula

BI-11-129-05
Castroviejo
Size1,



BI-11-130-12
Dix
Size1,



BI-11-131-13
Dix
Size1,



BI-11-132-13
Dix
Size1,



Castroviejo Caliper
BI-11-133-07
Castroviejo
8.3cm,

Ophthalmology



BI-11-134-13
ConninAmsler
Size1,



BI-11-135-06
Dastoor
Size1,



BI-11-136-09
Holth
Size1,



WilderLacrimaDilator
BI-11-137-03
Wilder
10.2cm,



ZIEGLERLacrimaDilator
BI-11-138-12
Ziegler
14cmDoubleEnd,



CastroviejoLacrimaDilator
BI-11-139-12
Castroviejo
14cm,

Ophthalmology



BI-11-140-78
Bowman
Size1,



BI-11-141-07
Graefe
Size1,



BI-11-142-07
Graefe
Size1,



BI-11-143-07
Graefe
Size1,



BI-11-144-07
Graefe
Size1,



BI-11-145-07
Fischer
Size1,

Ophthalmology



BI-11-146-07
BarraquerKatzin
Size1,



BI-11-147-07
Troutman
Size1,



BI-11-148-07
Barraquer
Size1,



BI-11-149-07
Barraquer
Size1,



BI-11-150-09
McCullough
Size1,



BI-11-151-09
McCullough
Size1,

Ophthalmology



BI-11-152-10
Jameson
Size1,



BI-11-153-10
Jameson
Size1,



BI-11-154-10
Bonaccolto
Size1,



BI-11-155-10
Bonaccolto
Size1,



BI-11-156-10
Dastoor
Size1,



BI-11-157-10
Dastoor
Size1,

Ophthalmology



BI-11-158-05
BishopHarman
Size1,



BI-11-159-08
BishopHarman
Size1,



BI-11-160-05
BishopHarman
Size1,



BI-11-161-08
BishopHarman
Size1,



BI-11-162-07
ModBonn
Size1,



BI-11-163-07
ModBonn
Size1,

Ophthalmology



BI-11-164-10
ModBonn
Size1,



BI-11-165-10
ModBonn
Size1,



BI-11-166-10
ModBonn
Size1,



BI-11-167-10
ModBonn
Size1,



BI-11-168-10
Prince
Size1,



BI-11-169-10
Prince
Size1,

Ophthalmology



BI-11-170-20
Berke
Size1,



BI-11-171-08
Troutman
Size1,



BI-11-172-05
Barraguer
Size1,



BI-11-173-11
Elsching
Size1,



BI-11-174-11
Graefe
Size1,



BI-11-175-09
Lester
Size1,

Ophthalmology



BI-11-176-09
Castroviejo
Size1,



BI-11-178-09
Castroviejo
Size1,



BI-11-179-09
Barraquer
Size1,



BI-11-180-10
Green
Size1,



BI-11-181-07
GillArruga
Size1,



BI-11-182-01
Castroviejo
Size1,

Ophthalmology



BI-11-183-05
Castroviejo
Size1,



BI-11-184-10
Moorfield
Size1,



BI-11-185-07
StMartin
Size1,



BI-11-186-10
ModTubingen
Size1,



BI-11-187-10
McPherson
Size1,



BI-11-188-10
McPherson
Size1,

Ophthalmology



BI-11-189-09
Ayer
Size1,



BI-11-190-09
Ayer
Size1,



BI-11-191-09
Desmarres
Size1,



BI-11-192-10
Snellen
Size1,



BI-11-1193-11
KnappLuer
Size1,



BI-11-194-28
Scheie
Size1,

Ophthalmology



BI-11-195-45
ModTubingen
Size1,



BI-11-196-00
Elliot
Size1,



BI-11-197-09
Beer
Size1,



BI-11-198-10
Barraquer



BI-11-199-09
Douglas
Size1,



BI-11-200-09
Gradle
Size1,

Ophthalmology



BI-11-177-09
Castroviejo
Size1,



BI-11-119-07
Mueller
Size1,

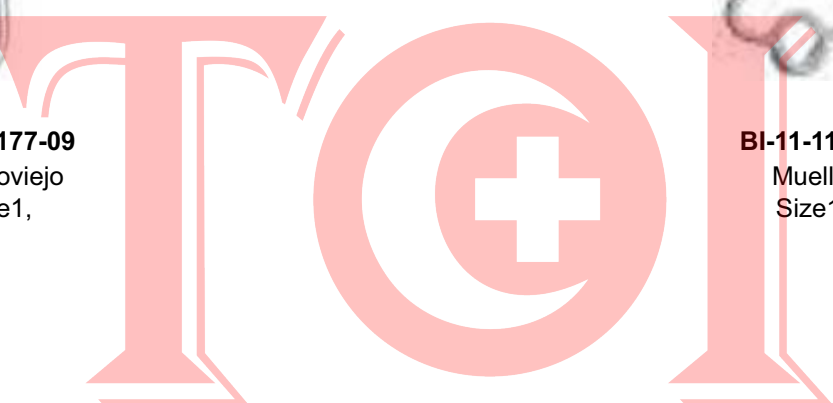

Tracheotomy

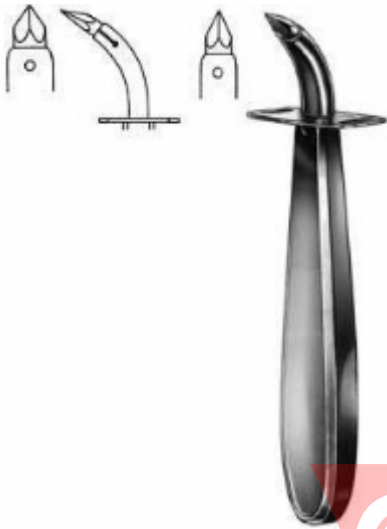

Ueckermann
BI-16-101-13
 Tracheotomy Trocar
 11.5cm,



Iterson
BI-16-102-16
 Tracheal Hook
 17cm,



Rose
BI-16-103-13
 Tracheal Hook
 13.5cm,



Luer
BI-16-104-11
 Tracheal Hook
 11cm,



BI-16-105-15
 Tracheal Hook
 15cm,



Lukens
BI-16-106-17
 Thymus Retractor
 17.5cm,

Tracheotomy



Jackson
BI-16-107-17
 TrachealHook
 18cm,



Kocher
BI-16-108-15
 GoitreEnucleator
 16.5cm,



Kocher
BI-16-109-15
 GoitreEnucleator
 16.5cm,



Hofmeister
BI-16-110-21
 GoitreEnucleator
 20.5cm,



Lahey
BI-16-111-15
 GoitreGraspingForceps
 15.5cm,



Luer
BI-16-112-04
 TrachealTube

Tracheotomy



Luer
BI-16-113-08
Tracheal Tube



Chevalier-Jackson
BI-16-114-04
Tracheal Tube outer tube closed inner tube closed silver

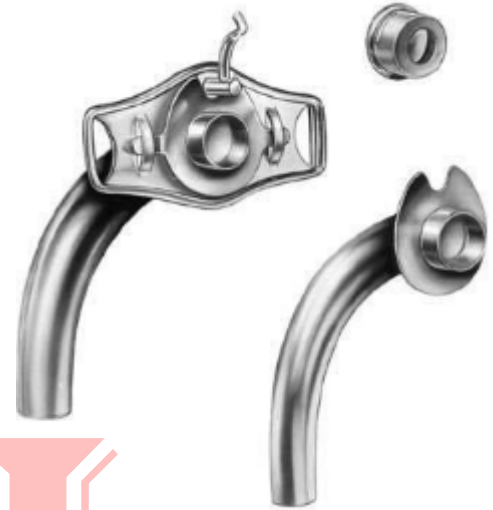

BI-16-115-08
Speaking Tube

Dermatology



Moncorps
BI-17-101-14
MiliumKnife
14cm,



Moncorps
BI-17-102-00
SpareBlade



Vidal
BI-17-103-14
LupusScraper
13cm,



Wolff
BI-17-105-01
LupusCurette
14cm,



Kilner
BI-17-106-15
SkinHooklet
14.5cm,



Gillies
BI-17-107-18
SkinHooklet
18cm,

Dermatology



Kaye
BI-17-108-03
 Face-liftHook
 13cm,

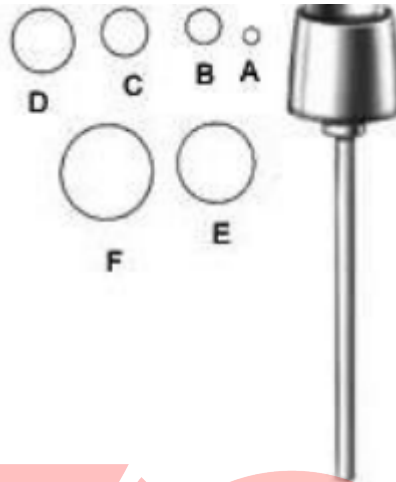

BI-17-109-02
 DermalPunch
 5.5cm,



Handle
BI-17-110-00
 8cm,

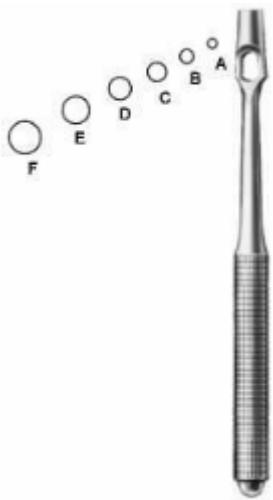

Keyes
BI-17-111-02
 DermalPunch
 11cm,



Unna
BI-17-113-14
 ComedoneExtractor
 14.5cm,



Saalfeld
BI-17-114-10
 ComedoneExtractor
 11cm,

Dermatology



Saalfeld
BI-17-115-14
 Saalfeld Comedone Extractor
 14.5cm,



Schamberg
BI-17-116-10
 Comedone Extractor
 9.5cm,



Katsch
BI-17-117-14
 Comedone Extractor
 16cm,



Unna-Vidal
BI-17-118-11
 Comedone Extractor
 11.5cm,



d'Assump?
BI-17-119-15
 Face-lift Forceps
 18cm,



Gregory
BI-17-120-14
 Face-lift Scissors
 14cm,

Dermatology



Kaye
BI-17-121-15
 Face-lift Scissors
 15cm, 18cm,



Stella-S
BI-17-122-18
 Face-lift Scissors
 18cm,



Gorney
BI-17-123-18
 Face-lift Scissors
 18cm,



Freeman-Kaye
BI-17-124-18
 Face-lift Scissors
 18cm,



Freeman
BI-17-125-00
 Face-lift Scissors
 23cm,



Fox
BI-17-104-01
 Lupus Curette
 14cm,

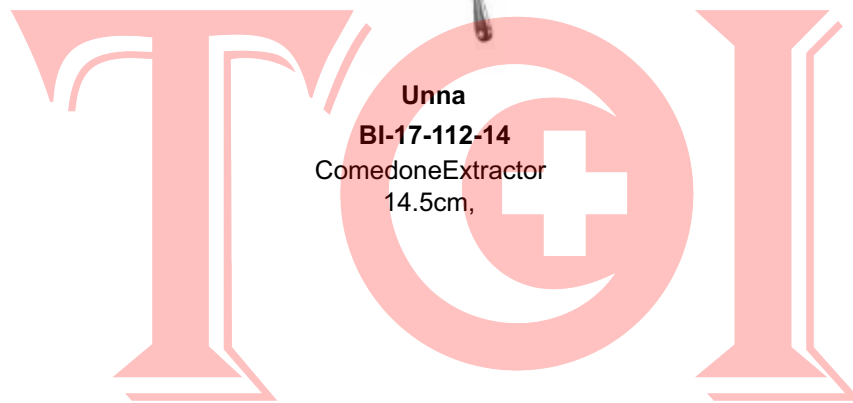
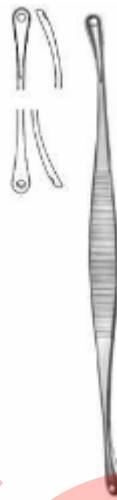

Unna
BI-17-112-14
Comedone Extractor
14.5cm,

Intestines & Stomach



Allis-Baby
BI-18-101-12

Intestinal and Tissue Grasping Forceps
13cm,

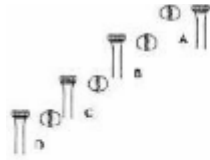

Allis
BI-18-102-15

Intestinal and Tissue Grasping Forceps
15.5cm, 19cm, 25.5cm,



Allis
BI-18-103-16

Intestinal and Tissue Grasping Forceps
15.5cm, 20cm, 24.5cm, 30cm,



Allis-Adair
BI-18-104-15

Intestinal and Tissue Grasping Forceps
16cm,



Boys-Allis
BI-18-105-15

Intestinal and Tissue Grasping Forceps
15.5cm,



Thoms-Allis
BI-18-106-20

Intestinal and Tissue Grasping Forceps
20.5cm,

Intestines & Stomach



Allis
BI-18-107-20

Intestinal and Tissue Grasping Forceps
20cm,



Lockwood
BI-18-108-20

Intestinal and Tissue Grasping Forceps
20cm,



Williams
BI-18-109-16

Intestinal and Tissue Grasping Forceps
16.5cm,

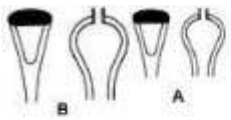

Babcock
BI-18-110-16

Intestinal and Tissue Grasping Forceps
16.5cm, 21cm,

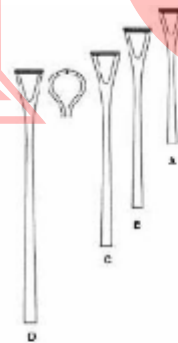

Babcock
BI-18-111-16

Intestinal and Tissue Grasping Forceps
15.5cm, 17.5cm, 21cm, 24cm,



Babcock
BI-18-112-16

Intestinal and Tissue Grasping Forceps
16cm, 20.5cm,

Intestines & Stomach



Duval
BI-18-113-20
 Intestinal and Tissue Grasping Forceps
 20.5cm,

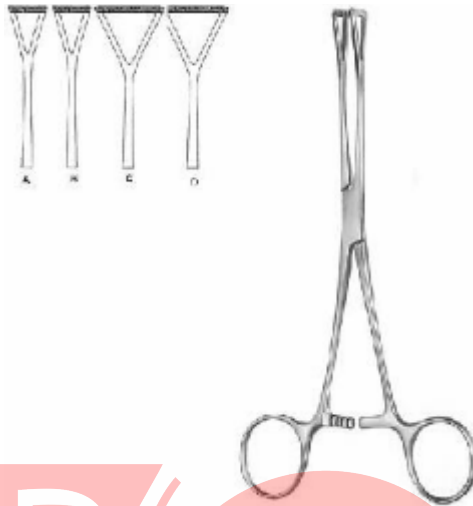

Duval
BI-18-114-18
 Intestinal and Tissue Grasping Forceps
 18cm, 20.5cm, 23cm,

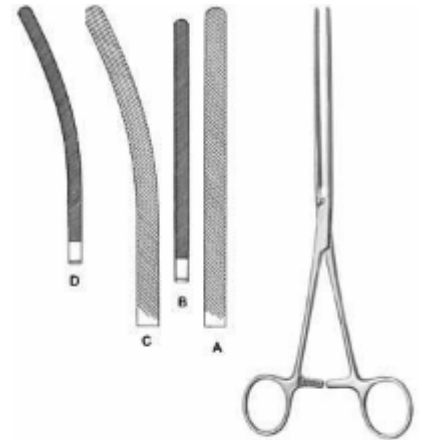

Doyen
BI-18-115-21
 Intestinal Clamp
 21.5cm, 23.5cm,



Doyen-Baby
BI-18-116-18
 Intestinal Clamp
 18cm, 17.5cm,

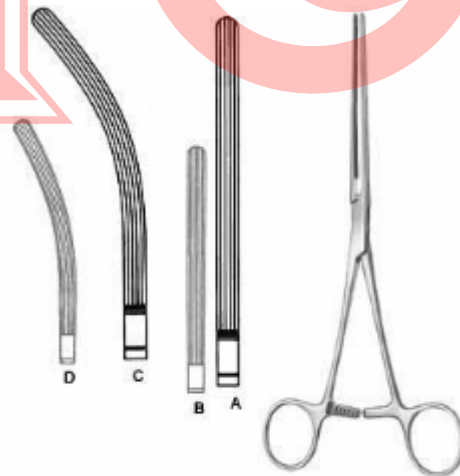

Mayo-Robson
BI-18-117-21
 Intestinal Clamp
 21.5cm, 23.5cm, 23cm,

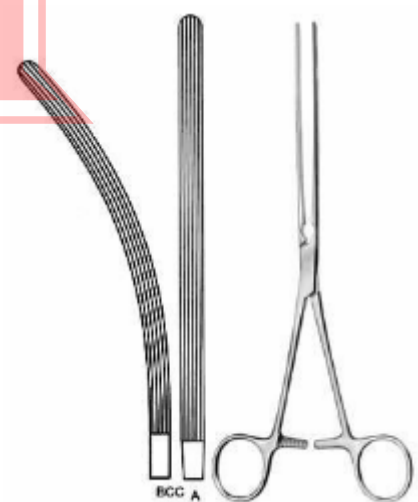

Mayo-Robson
BI-18-118-25
 Intestinal Clamp
 25.5cm, 24.5cm,

Intestines & Stomach

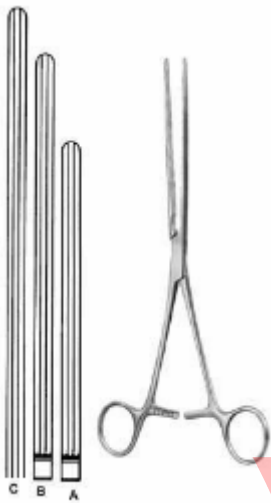

Kocher
BI-18-119-22
 IntestinalClamp
 22.5cm,25cm,28.5cm,

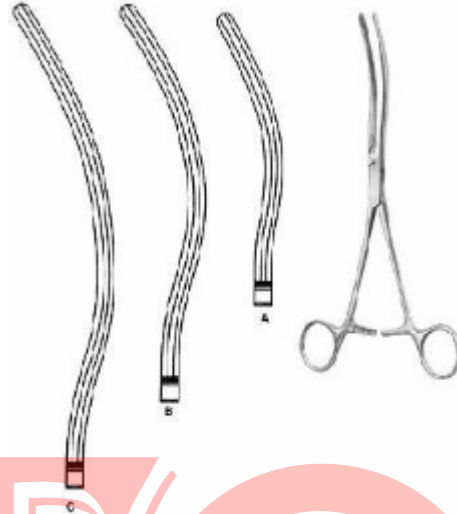

Kocher
BI-18-120-22
 IntestinalClamp
 22cm,24.5cm,27.5cm,



Allen
BI-18-121-16
 IntestinalClamp
 16cm,



Payr-Baby
BI-18-122-15
 IntestinalandPylorusClamp
 15cm,

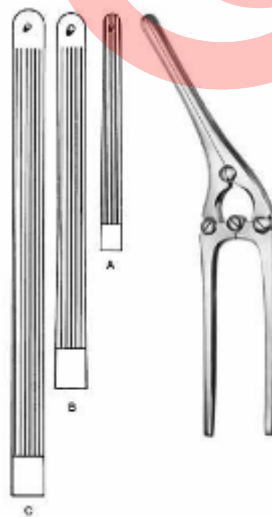

Payr
BI-18-123-21
 IntestinalandPylorusClamp
 20.5cm,29cm,34.5cm,



Stone-Watt
BI-18-124-07
 IntestinalAnastomosisClamp
 8.5cm,10cm,

Intestines & Stomach



Stone-Watt
BI-18-125-15
 Closing Forceps

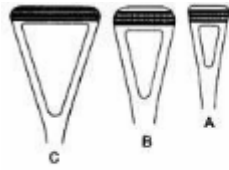

Scheibe
BI-18-126-18
 Organ Grasping Forceps
 18cm,



Doyen-Baby
BI-18-127-13
 Intestinal Clamp
 14cm, 17cm,

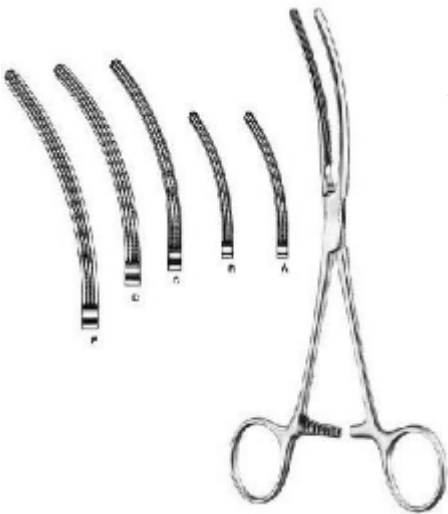

Doyen-Baby
BI-18-128-13
 Intestinal Clamp
 13.5cm, 17cm,



Mayo-Robson
BI-18-129-25
 Intestinal Clamp
 26cm,



Mayo-Robson
BI-18-130-25
 Intestinal Clamp
 25cm,

Intestines & Stomach

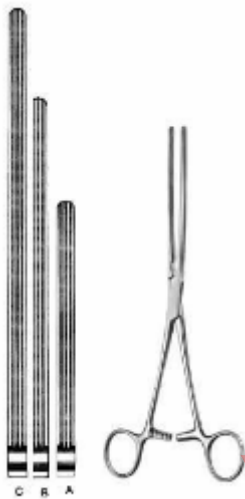

Kocher
BI-18-131-22
 IntestinalClamp
 22.5cm,28cm,



Kocher
BI-18-132-22
 IntestinalClamp
 22cm,25cm,27.5cm,



Scudder
BI-18-133-33
 IntestinalClamp
 33.5cm,

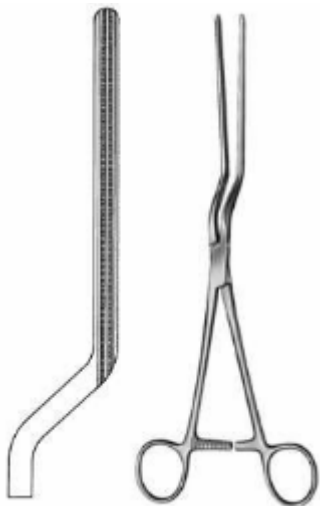

Brunner
BI-18-134-24
 SigmoidAnastomosisForceps
 27cm,



Hayes
BI-18-135-26
 SigmoidAnastomosisForceps
 27cm,28cm,



Veidenheimer
BI-18-136-23
 SigmoidAnastomosisForceps
 25cm,

Intestines & Stomach



Fehland
BI-18-137-24
 Sigmoid Anastomosis Forceps
 24cm,



Resano
BI-18-138-30
 Sigmoid Anastomosis Forceps
 28cm,



Sims
BI-18-139-15
 Rectal Speculum
 15.5cm,



Sims
BI-18-140-15
 Rectal Speculum
 15.5cm,



Mathieu
BI-18-141-19
 Rectal Speculum
 19cm,



Alan-Parks
BI-18-142-00
 Alan-Parks
 14cm,

Intestines & Stomach

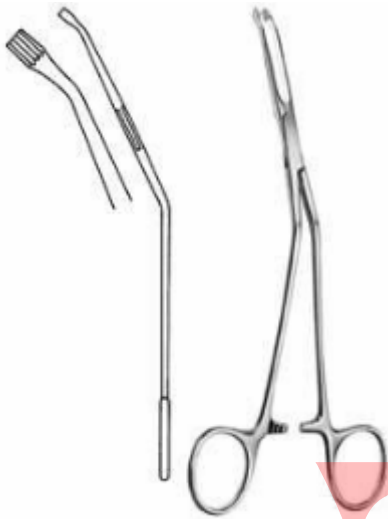

McGinvey
BI-18-143-19
Hemorrhoidal Grasping Forceps
19cm,



BI-18-144-00
Handle for biopsy forceps



BI-18-145-38
Rectal Biopsy Forceps

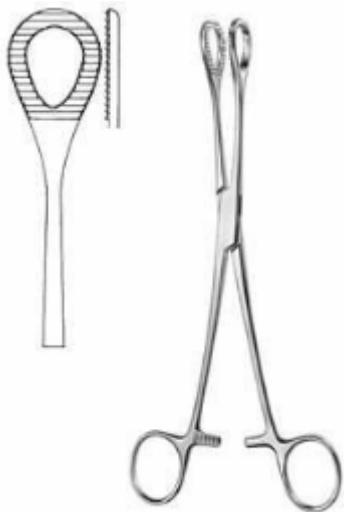

Heywood-Smith
BI-18-146-21
Polypus Grasping Forceps
21cm,

Urology

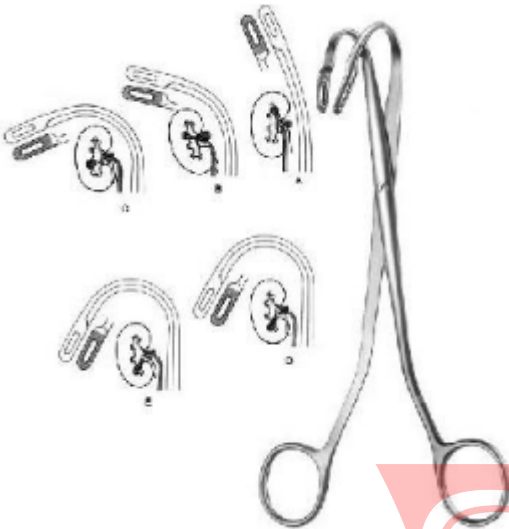

Randall

BI-19-101-23A

Kidney Stone Forceps

23cm Fig. 1, 21cm Fig. 2, 19cm Fig. 3,



Randall

BI-19-102-23A

Kidney Stone Forceps

23cm, 24.5cm,

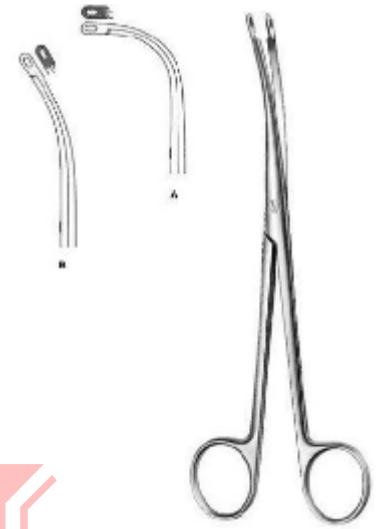

Heiming

BI-19-103-16A

Kidney Stone Forceps

16cm Fig. 1, 17cm Fig. 2,

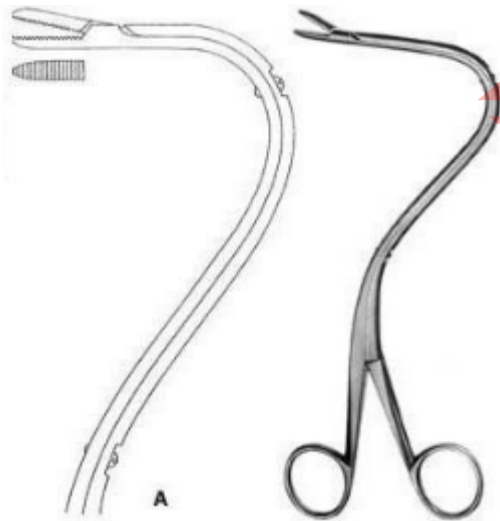

Elsasser

BI-19-104-01A

Nephrostomy Forceps

21cm Fig. 1, 21cm Fig. 2,



Bakes

BI-19-105-01A

Gall Duct Dilator

32cm,

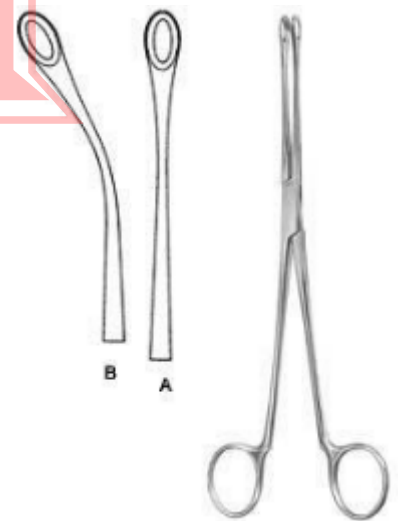

Blake

BI-19-106-20A

Gall Stone Forceps

21cm,

Urology



Mayo-Blake
BI-19-107-20
GallStoneForceps
21cm,



Mayo-Blake
BI-19-108-20
GallStoneForceps
21cm,



Mixer
BI-19-109-22
GallStoneForceps
21.5cm,



Desjardins
BI-19-110-23A
GallStoneForceps
23cm,

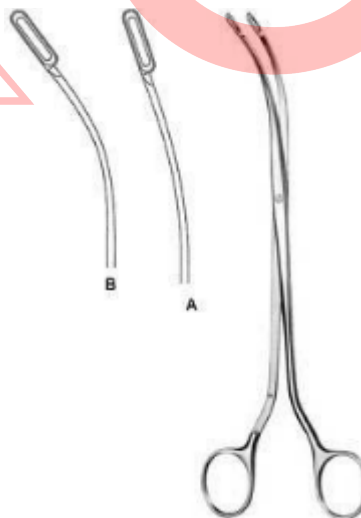

Desjardins
BI-19-111-24A
GallStoneForceps



Luer-Korte
BI-19-112-01A
GallStoneScoop
32cmFig.0,32cmFig.00,32cmFig.
000,32cmFig.1,32cmFig.2,32cmFig.
3,32cmFig.4,

Urology

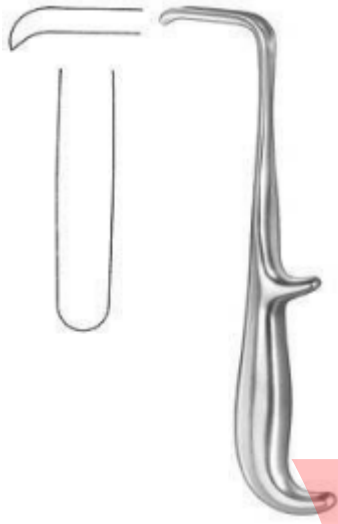

Young
BI-19-113-21
 Prostatic Retractor
 21.5cm,



Young
BI-19-114-22
 Prostatic Retractor
 20.5cm,

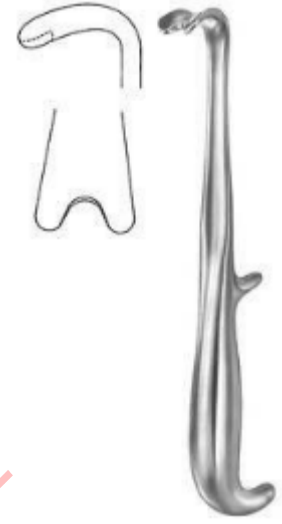

Young
BI-19-115-21
 Prostatic Retractor
 22cm,

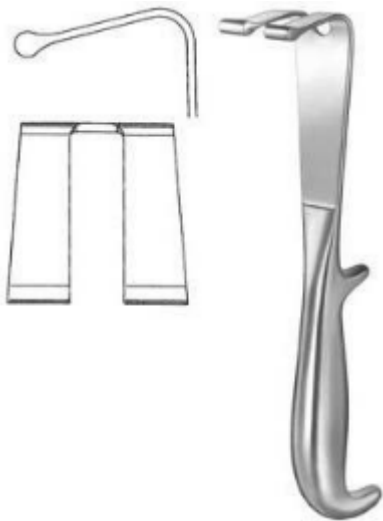

Young
BI-19-116-22
 Prostatic Retractor
 21.5cm,



Millin
BI-19-117-24
 Capsule Forceps
 24.5cm,

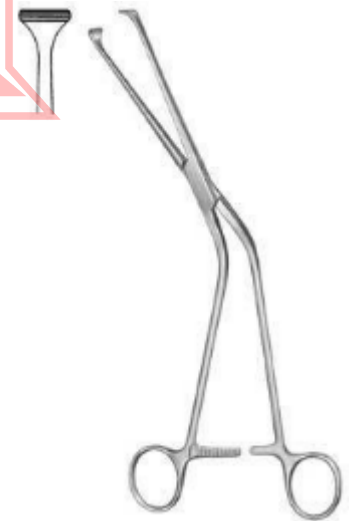

Millin
BI-19-118-24
 Capsule Forceps
 22cm,

Urology

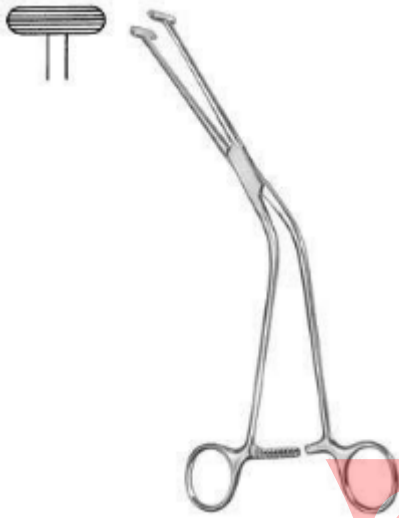

Millin
BI-19-119-23
 Capsule Forceps
 24.5cm,

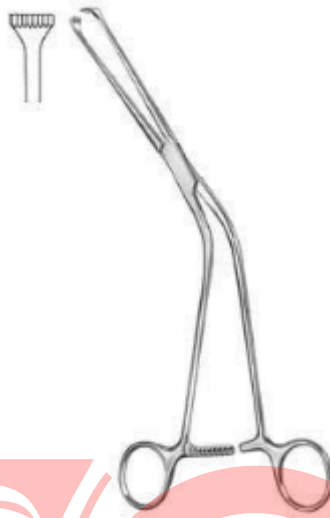

Millin
BI-19-120-23
 Capsule Forceps
 22cm,

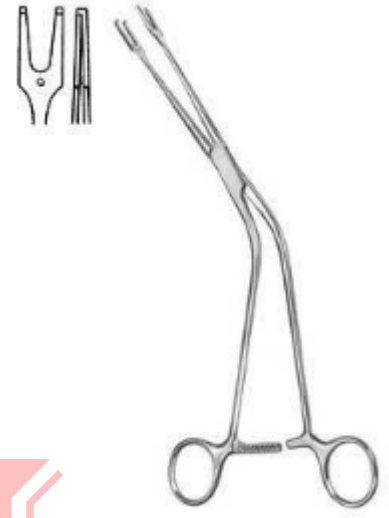

Millin
BI-19-121-24
 Ligature Carrying Forceps
 24.5cm,



Millin
BI-19-122-00
 Bladder Neck Spreader
 29,



Thomson-Walker
BI-19-123-00
 Bladder Retractor

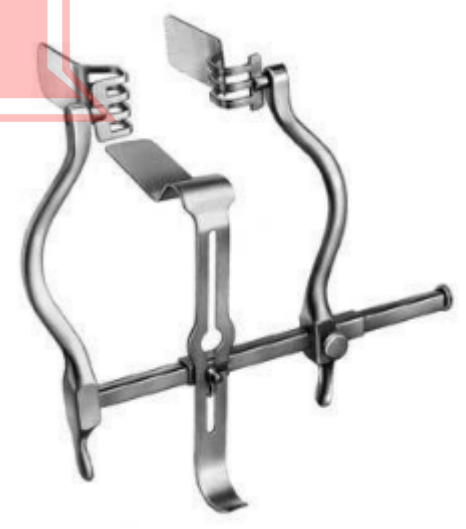

Judd-Masson
BI-19-124-00
 Bladder Retractor

Urology



Millin

BI-19-125-00A
Bladder Retractor



Legueu

BI-19-126-27
Bladder Spatula
24cm 35mm,



VanBuren

BI-19-127-00A
Urethral Sound
27.5cm,

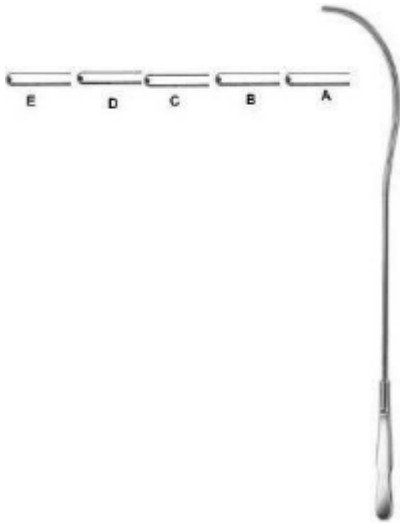

Guyon

BI-19-128-10A
Urethral Sound
26cm,

Gynecology



Cusco
BI-20-101
Vaginal Speculum
75x32mm, 85x35mm,



Cusco
BI-20-102-01
Vaginal Speculum
75x18mm,



Cusco
BI-20-103-01
Vaginal Speculum
80x22mm, 100x25mm, 105x27mm,



Cusco
BI-20-104-01
Vaginal Speculum
75x34mm, 85x37mm,



Collin
BI-20-105-01
Vaginal Speculum
85x30mm, 100x35mm,

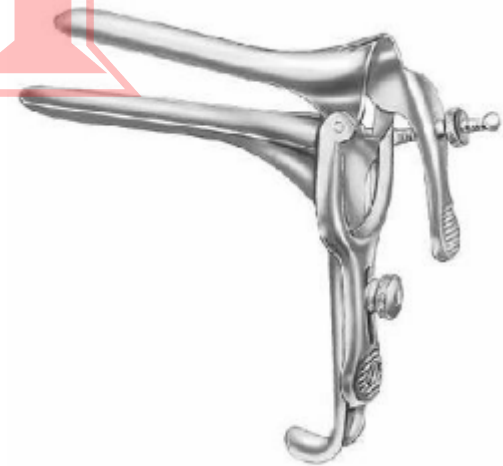

Pederson
BI-20-106-01
Vaginal Speculum
75x13mm, 100x22mm,

Gynecology



Grave

BI-20-107-01

Vaginal Speculum
75x20mm, 95x35mm,



Semm

BI-20-108-01

Vaginal Speculum
100x20mm, 105x27mm,



Sims

BI-20-109-01

Vaginal Speculum
65x25mm, 70x30mm,



Kristeller

BI-20-110-01

Vaginal Speculum
70x27mm,



Kristeller

BI-20-111-01

Vaginal Retractor
75x23mm,



Kristeller

BI-20-112-01

Vaginal Speculum
Size 1,

Gynecology



Kristeller
BI-20-113-01
Vaginal Speculum
105x18mm,



Kristeller
BI-20-114-01
Vaginal Retractor
110x14mm,



Kristeller
BI-20-115-01
Vaginal Speculum
Size 1,



Kristeller
BI-20-116-01
Vaginal Speculum
105x26mm,

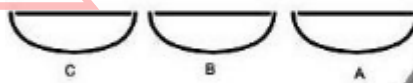

Kristeller
BI-20-117-01
Vaginal Retractor
115x22mm, 115x24mm,

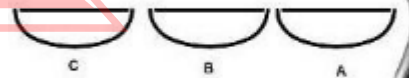

Kristeller
BI-20-118-01
Vaginal Speculum
Size 1,



Gynecology



Kristeller
BI-20-119-01
Vaginal Speculum
110x27mm,

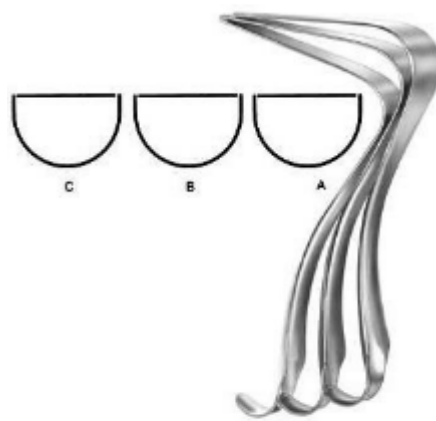

Kristeller
BI-20-120-01
Vaginal Retractor
115x23mm,



Kallmorgen
BI-20-121-01
Vaginal Speculum



Kallmorgen
BI-20-122-01
Vaginal Retractor
70x40mm Fig.1, 90x40mm Fig.2,



Kallmorgen
BI-20-123-01
Vaginal Speculum
70x33mm, 90x33mm,

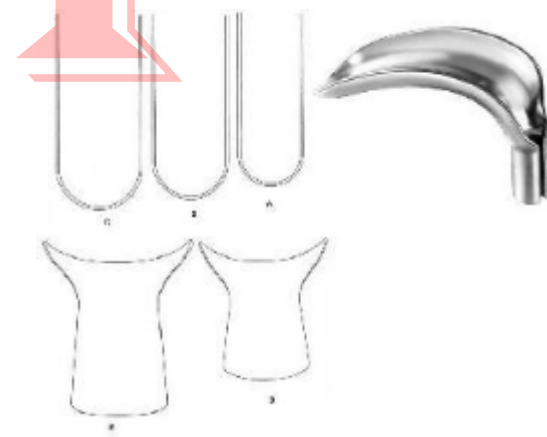

Scherbak
BI-20-125-00
Vaginal Speculum
Size1,

Gynecology



Auvard
BI-20-126-22
 Vaginal Speculum
 80x43mm,



Weissbarth
BI-20-127-24
 Vaginal Speculum
 21cm80x42mm,



Breisky
BI-20-128-20
 Vaginal Speculum
 29cm100x20mm, 29cm100x25mm,



Kogan
BI-20-129-24
 Endocervical Speculum
 25cm70x30mm,



Kogan
BI-20-130-24
 Endocervical Speculum
 24.5cm,



Hegar
BI-20-131-24
 Uterine Dilator
 18.5cm1,0,

Gynecology



Hegar
BI-20-132-02
 Uterine Dilator
 20cm 1,0,



Hank
BI-20-133-10
 Uterine Dilator
 26.5cm Fig.9/10,



Sims
BI-20-134-32
 Uterine Sound
 33cm,



Valleix
BI-20-135-25
 Uterine Sound
 29.5cm,



Braun
BI-20-136-26
 Uterine Depressor
 27.5cm,



Schroder
BI-20-137-25
 Uterine Tenaculum Forceps
 25.5cm,

Gynecology



Braun
BI-20-138-25
Uterine Tenaculum Forceps
26cm,



Duplay
BI-20-139-28
Uterine Tenaculum Forceps
25.5cm,



Beacham
BI-20-140-26
Amniotome
26cm,



Skene
BI-20-141-24
Uterine Tenaculum Forceps
24cm,



Schroder
IN-20-142-24
Uterine Tenaculum Forceps
25cm,



Teale
BI-20-143-23
Uterine Tenaculum Forceps
23.5cm,

Gynecology



Iowa
BI-20-144-26
 Uterine Tenaculum Forceps
 26cm,



Museux
BI-20-145-24
 Uterine Tenaculum Forceps
 24cm,



Jacobs
BI-20-146-21
 Uterine Tenaculum Forceps
 21cm,

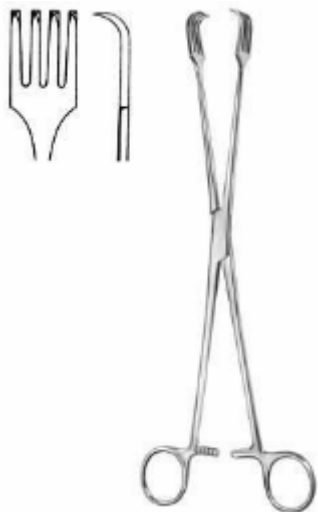

BI-20-147-26
 Uterine Tenaculum Forceps
 26.5cm,



Braun
BI-20-148-16
 Uterine Tenaculum Forceps
 16cm,

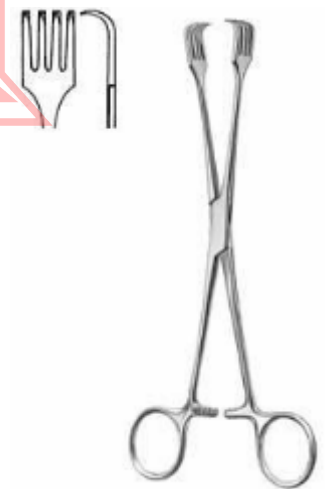

Czerny
BI-20-149-21
 Uterine Tenaculum Forceps
 21cm,

Gynecology



Kelly
BI-20-150-32
Uterine Polypus Forceps
32cm,



Noto
BI-20-151-27
Uterine Polypus Forceps
27cm,

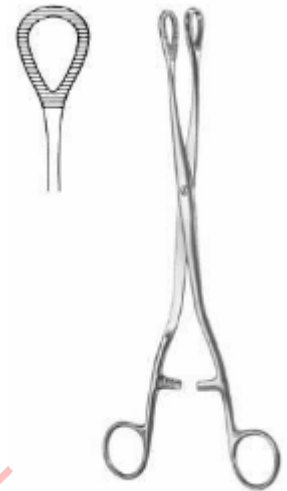

Heywood-Smith
BI-20-152-25
Uterine Polypus Forceps
25cm,



Doyen
BI-20-153-17
Myoma Screw
17cm,



Doyen
BI-20-154-17
Myoma Screw
14.5cm,



Segond
BI-20-155-27
Myoma Knife
28cm,

Gynecology



Dartigues

BI-20-156-27

Uterine Seizing Forceps
28cm,



Somer

BI-20-157-27

Uterine Seizing Forceps
22.5cm,



Collin

BI-20-158-25

Uterine Seizing Forceps jaw 40mm wide
26cm,



Ayre

BI-20-159-23

Conization Knife cutting edge 3,6mm wide
23.5cm,



Emmett

BI-20-160-03

Fistula Hook
22cm Fig.3,



Simon

BI-20-161-22

Fistula Hook
21.5cm,

Gynecology



Simon
BI-20-162-22
 Fistula Hook
 21.5cm,



Novak
BI-20-163-23
 Suction Curette 4mm?
 24.5cm,



Kevorkian
BI-20-164-23
 Uterine Biopsy Curette 6,0mm?
 30cm,



Munchen
BI-20-165-27
 Uterine Biopsy Curette 4,8mm?
 27cm,



Gellhorn
BI-20-166-23
 Uterine Biopsy Forceps jaw 8,6mm wide
 24cm,

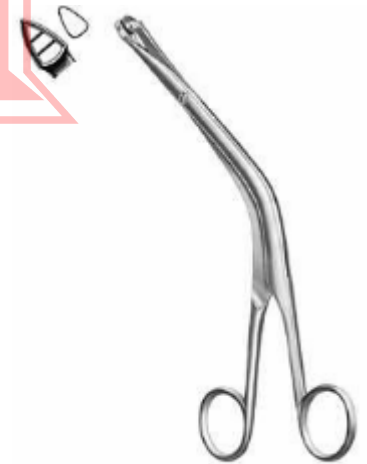

Faure
BI-20-167-21
 Faure Uterine Biopsy Forceps
 21cm,

Gynecology



Schubert
BI-20-168-21

Uterine Biopsy Forceps jaw 4,8mm wide
21.5cm, 28cm,



Thoms-Gaylor
BI-20-169-22

Uterine Biopsy Forceps jaw 5,6mm?
21cm, 23.5cm,



Schubert
BI-20-170-26

Schubert Uterine Biopsy Forceps
25.5cm,

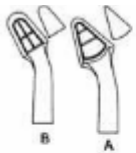

VanDoren
BI-20-171-24

Uterine Biopsy Forceps jaw 4,9mm wide
27cm, 25.5cm,



Alexander
BI-20-172-28

Uterine Biopsy Forceps jaw 5,1mm wide
28cm,



Kevorkian
BI-20-173-32

Uterine Biopsy Forceps
25cm,

Gynecology

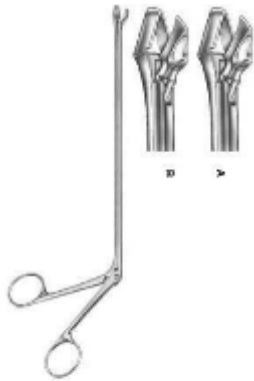

Schumacher
BI-20-174-01

Uterine Biopsy Forceps jaw 4,6/5,4mm wide
24cm,



Schumacher
BI-20-175-00

Uterine Biopsy Forceps
25cm,



BI-20-176-22

IUP Grasping Forceps 3mm?
22cm,

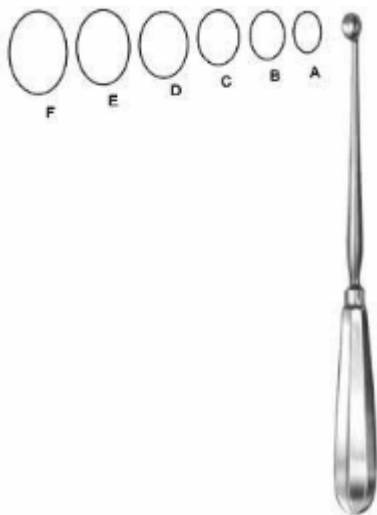

Simon

BI-20-177-01

Uterine Scoop

24.5cm 9,8x8,6mm, 24.5cm 11,6x8,3mm,



Simon

BI-20-178-01

Uterine Scoop

30cm 9,8x8,6mm, 30cm 11,6x8,3mm,



Recamier

BI-20-179-05

Uterine Curette

31cm Fig.005mm, 31cm Fig.06mm,

Gynecology



Recamier
BI-20-180-05

UterineCurette

31cmFig.005mm,31cmFig.06mm,



Sims

BI-20-181-05

UterineCurette

31cmFig.005mm,31cmFig.06mm,



Sims

BI-20-182-05

UterineCurette

31cmFig.005mm,31cmFig.06mm,



BI-20-183-03

SuctionCurette

29cm3,0mm?,29cm4,5mm?,29cm6,0mm?,

Obstetrics



Martin
BI-21-101-34
 Pelvimetercm, inchscale
 34cm,



Nagele
BI-5-102-36
 ObstetricalForceps
 35cm,40.5cm,



Simpson
BI-5-103-30
 ObstetricalForceps
 31cm,



Wrigley
BI-5-104-28
 ObstetricalForceps
 28cm,



Simpson
BI-21-105-36
 ObstetricalForceps
 36.5cm,



Kielland
BI-21-106-41
 ObstetricalForceps
 42cm,

Obstetrics

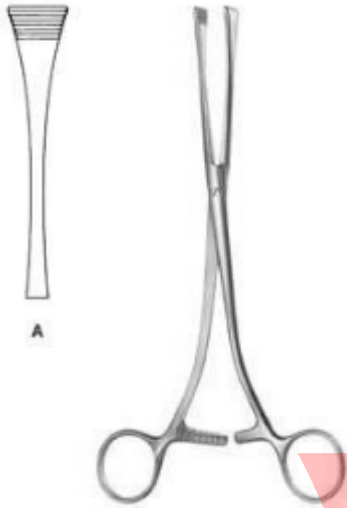

Green-Armytage
BI-21-107-21
 Uterine Clamp
 21cm,



Sellheim
BI-21-108-28
 Obstetrical Lever
 32cm,

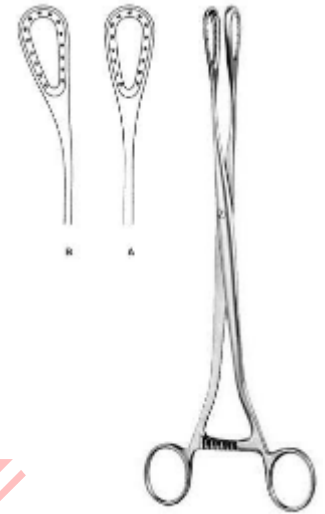

Sanger
BI-21-109-27
 Placenta and Ovum Forceps
 27.5cm, 27cm,

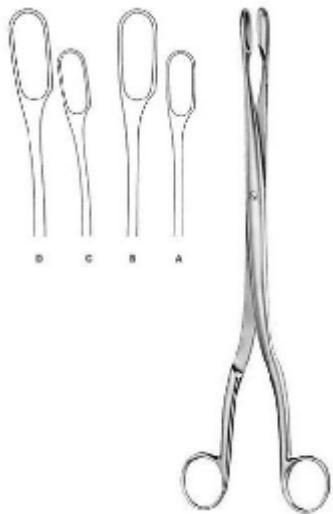

Winter
BI-21-110-01
 Placenta and Ovum Forceps
 28cm Fig.1, 28cm Fig.2,

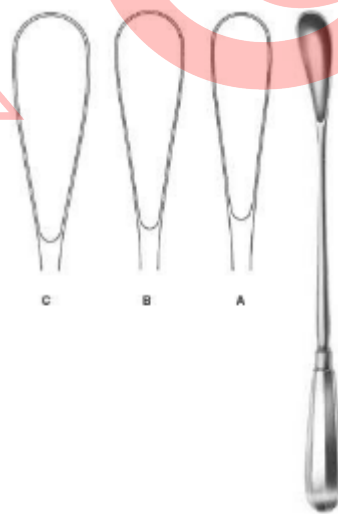

Cuzzi
BI-21-111-01
 Placenta Scoop
 30cm 14,5mm, 30cm 18mm,



Pestalozza
BI-21-112-30
 Placenta Scoop
 30cm,

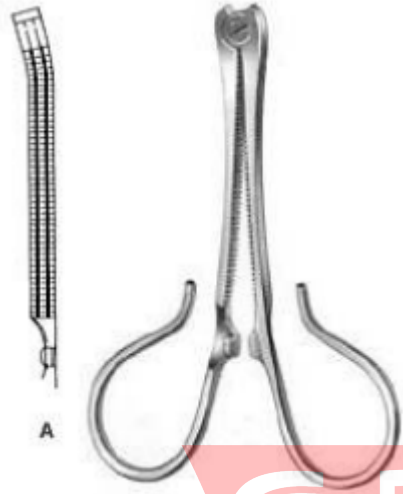

Kane
BI-21-113-08
UmbilicalCordClamp
8.5cm,



Collin
BI-21-114-09
UmbilicalCordClamp
8.5cm,

Sterilization



Irrigator
BI-23-101-10
Size1,



RoundBowl
BI-23-102-16
220mmx70mm,400mmx150mm,



BI-23-103-33
RoundBowl
?xh6,00l,



FlatDish
BI-23-104-11
?xh0,20l,



Lidonly
BI-23-105-11
Size1,



StainlessSteel
BI-23-106-04
?xh0,30l,

Sterilization



RoundDish
BI-23-107-11

?xh0,30l,?128x38mm0,40l,



FlatDish
BI-23-108-11

?xh0,15l,



Measurer
BI-23-109-01

graduatedinside
100cc=0,1l,



Measurer
BI-23-110-02

GraduatedInside
0,25l,0,50l,



PetriDish
BI-23-111-10

withLid?xh



PetriDish
BI-23-112-09

withoutlid?xh
Size1,

Sterilization



LidforPetriDishes
BI-23-113-10
Size1,



UniversalTray
BI-23-114-23
lxbxh,



InstrumentTray
BI-23-115-21
lxbxh,



UniversalTray
BI-23-116-23
lxbxh,



RoundBowl
BI-23-117-22
?xh,



MetalJar
BI-23-118-30
?30mmx90mm, ?50mmx100mm,

Sterilization



InstrumentBox
BI-23-119-16
lidwithknob
lxbxh,



InstrumentBox
BI-23-120-16
lidwithknob
lxbxh,



InstrumentBox
BI-23-121-20
lxbxh,



RoundMetalBox
BI-23-122-06
775mmx75mm, ?100mmx60mm,



MedicineCupGraduatedInside
BI-23-123-25
25ccm,



MedicineCupGraduatedInside
BI-23-124-50
50ccm,

Sterilization



TabletTray
BI-23-125-75
?75mmx12mm,



MetalCup
BI-23-126-90
?90mmx90mm,



DentureCup
BI-23-127-75
?75mmx50mm,



InsertforCup
BI-23-128-75
?73mmx75mm,



KidneyDish
BI-23-129-17
lxbxh,



PlacentaPan
BI-23-130-36
Size1,

Sterilization



Waste Cotton Collector
BI-23-131-01
75mmx75mm,



Spirit Lamp
BI-23-132-07
120ccm,

Bone Surgery



Charrière
BI-7-102-35
Amputation Saw
35cm,



Langenbeck
BI-7-103-23
Amputation Saw
24.5cm,



Charrière
BI-7-104-27
Amputation Saw
26.5cm,



BI-7-105-14
Reamer
13.5cm,



Perthes
BI-7-106-18
Reamer
18cm,



Perthes
BI-7-107-21
Reamer
21.5cm,

Bone Surgery



BI-7-108-14
Reamer
14cm,



BI-7-111-18
FlatTrephine



BI-7-112-01
WireTwistingForceps
15.5cm, 18cm, 20cm,



BI-7-113-15
WireTwistingForceps
15.5cm,

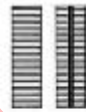

BI-7-114-17
FlatNosePlier
18.5cm,



BI-7-115-18
WireTwistingForceps
19cm,

Bone Surgery



BI-7-116-15
Combi-FlatNosePlier
15cm,

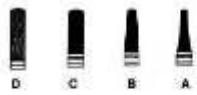

BI-7-117-01
FlatNosePlier
18cm,

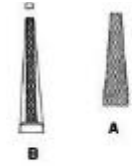

BI-7-118-14
FlatNosePlier
13.5cm,



Hackstock
BI-7-119-16
FlatNosePlier
16cm,

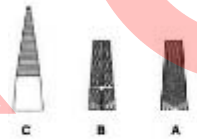

BI-7-120-01
FlatNosePlier
17.5cm,



BI-7-121-18
WireCuttingPliers
18.5cm,

Bone Surgery



BI-7-122-15
Wire Cutting Pliers
15cm,



BI-7-123-18
Wire Cutting Pliers
17.5cm,



Demel
BI-7-124-18
Wire Guide
31cm Fig.1, 29cm Fig.2, 28cm Fig.3,

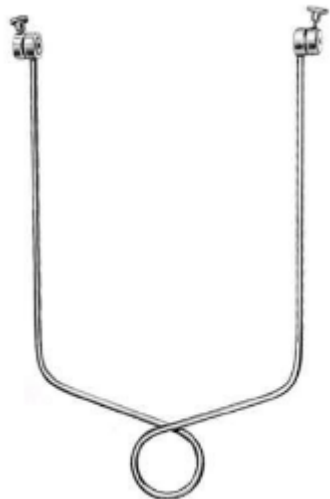

Bohler
BI-7-125-15
Extension Bow



Kirschner
BI-7-126-01
Extension Bow
18.5cm, 26.5cm,



BI-7-127-06
Traction Hook for Extension Bows

Bone Surgery



Kirschner
BI-7-128-06
WireDrill
6cm, 12cm,



Kirschner
BI-7-129-06
WireDrill
14cm, 16cm,



Kirschner
BI-7-130-10
WireDrill
31cm,

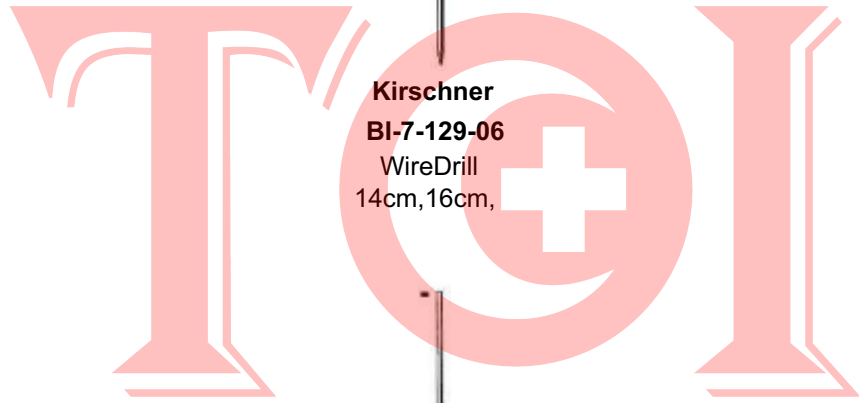

Kirschner
BI-7-131-10
WireDrill
6cm, 12cm, 18cm,



Kirschner
BI-7-132-10
WireDrill
31cm,

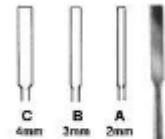

Buckley
BI-7-133-02
Chisel
16cm,

Bone Surgery



Buckley
BI-7-134-02
 Gouge
 16cm,



Stout
BI-7-135-03
 BoneChisel
 21cm,



BI-7-136-04
 BoneChisel
 18cm,



BI-7-137-04
 BoneChisel
 18cm,



BI-7-138-04
 BoneChisel
 17cm,



BI-7-139-04
 BoneChisel
 17cm,

Bone Surgery

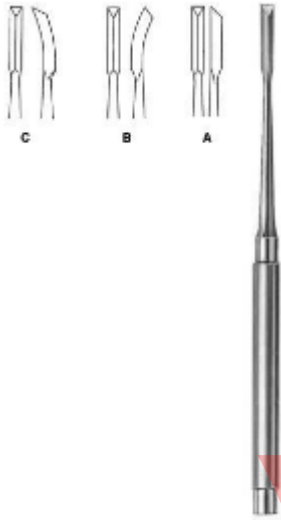

Gardner
BI-7-140-01
 BoneChisel
 17cm4mm,



Snyder-O.S.U.
BI-7-141-03
 BoneChisel
 16.5cm3mm, 16.5cm5.5mm,



O.S.U.
BI-7-142-01
 oneChisel
 17cm7mm,



O.S.U.
BI-7-143-01
 oneChisel
 17cm9mm,



BI-7-144-08
 Osteotome
 13.5cm8mm, 13.5cm10mm, 13.5cm
 12mm, 13.5cm14mm, 13.5cm16mm,



BI-7-145-08
 Chisel
 13.5cm8mm, 13.5cm10mm, 13.5cm
 12mm, 13.5cm14mm, 13.5cm16mm,